

# FLEXICODE

Interface Description



Copyright by Carl Valentin GmbH / 7979015.0125

Information on the scope of delivery, appearance, performance, dimensions, and weight reflect our knowledge at the time of printing.

We reserve the rights to make modifications.

All rights, including those regarding the translation, are reserved.

No part of this document may be reproduced in any form (print, photocopy, or any other method) or edited, copied, or distributed electronically without written permission from Carl Valentin GmbH.

Due to the constant further development of our devices discrepancies between manual and device can occur.

Please check [www.carl-valentin.de](http://www.carl-valentin.de) for the latest update.

### **Trademarks**

All named brands or trademarks are registered brands or registered trademarks of their respective owners and may not be separately labelled. It must not be concluded from the missing labelling that it is not a registered brand or a registered trademark.

Carl Valentin direct print modules comply with the following EU directives:

- CE** Low-Voltage Directive (2014/35/EU)
- Electromagnetic Compatibility Directive (2014/30/EU)



### **Carl Valentin GmbH**

Neckarstraße 78 – 86 u. 94  
78056 Villingen-Schwenningen

Phone +49 7720 9712-0  
E-Mail [info@carl-valentin.de](mailto:info@carl-valentin.de)  
Internet [www.carl-valentin.de](http://www.carl-valentin.de)

## Table of Contents

<b>1</b>	<b>Serial Data Transmission</b>	<b>5</b>
1.1	Connector Assignment (9-pin DSUB Socket)	5
1.2	Connection Plan RS232	6
<b>2</b>	<b>Parallel Data Transmission</b>	<b>7</b>
2.1	Connection Plan	7
<b>3</b>	<b>Text, Bar Code, Graphic</b>	<b>9</b>
3.1	Definition of Rotation	9
3.2	Definition of Datum Point	9
<b>4</b>	<b>Data Format</b>	<b>11</b>
4.1	Explication	12
4.2	Definition of Field Attributes/Field Properties (optional)	13
4.3	Field Name	14
4.4	Field Selection by Free Definable Field Number	18
<b>5</b>	<b>Mask Set</b>	<b>19</b>
5.1	Text	19
5.2	One-Dimensional Bar Code	21
5.3	ITF Bar Code	22
5.4	PDF417	23
5.5	MAXICODE	24
5.6	DataMatrix	25
5.7	GS1 DataMatrix	26
5.8	CODABLOCK F	27
5.9	GS1 DataBar (RSS Code)	28
5.10	QR Code	29
5.11	Aztec Code	30
5.12	Rectangle	31
5.13	Line	31
5.14	Internal Graphic	32
<b>6</b>	<b>Text Set</b>	<b>33</b>
6.1	Examples	34
<b>7</b>	<b>Graphic Set</b>	<b>35</b>
7.1	General Graphic Format	35
7.2	Graphic in PCX Format	35
7.3	Example PCX File	36
<b>8</b>	<b>Variables</b>	<b>37</b>
8.1	Set Structure	37
8.2	Link Field	37
8.3	Counter	38
8.4	Extended Counter	39
8.5	Date and Time	40
8.6	Format Identifier (Date & Time)	41
8.7	Currency Variable	44
8.8	Shift Variable	45
8.9	User Guiding	46
8.10	User Guiding with Mask	47
8.11	Memory Card Data	48
8.12	GS1-128 Parser	48
8.13	EPC Calculation (Electronic Product Code)	49
8.14	Check Digit	50
8.15	Substring	51

<b>9</b>	<b>Parameter Sets .....</b>	<b>53</b>
9.1	Layout Parameters .....	53
9.2	Machine Parameters .....	57
9.3	Device Settings.....	58
9.4	Ribbon Save .....	63
9.5	Interface.....	65
9.6	Network .....	67
9.7	Sensors .....	71
9.8	Offset Values .....	71
9.9	Service Functions .....	72
9.10	Date & Time.....	75
9.11	Password.....	78
9.12	Compact Flash Card.....	80
9.13	Printing .....	84
9.14	Emulation.....	88
<b>10</b>	<b>Parameter Sets for C Mode .....</b>	<b>89</b>
10.1	Machine Parameters .....	89
10.2	I/O Parameters .....	91
<b>11</b>	<b>Parameter Sets for I Mode .....</b>	<b>93</b>
11.1	Machine Parameters .....	93
11.2	I/O Parameters .....	95
<b>12</b>	<b>Configuration &amp; Status .....</b>	<b>99</b>
12.1	Autostatus.....	100
<b>13</b>	<b>Monitored Printing.....</b>	<b>103</b>
13.1	Short Introduction .....	103
13.2	Parameter Sets (Host – Printer).....	103
13.3	Direct Enquiry .....	104
13.4	Answer Sets (Printer – Host).....	104
13.5	Sample Label.....	106
<b>14</b>	<b>Font Examples .....</b>	<b>107</b>
14.1	Bitmap Fonts (Not Proportional).....	107
14.2	Bitmap Fonts (Proportional) .....	107
14.3	Vector Fonts .....	107
<b>15</b>	<b>Index .....</b>	<b>109</b>

# 1 Serial Data Transmission

## 1.1 Connector Assignment (9-pin DSUB Socket)

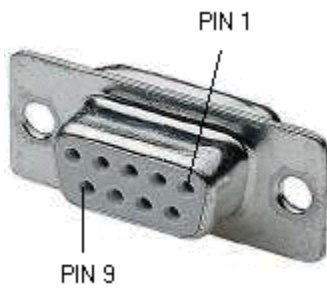

Pin	Signal	Description
2	T x D	Transmitting data line
3	R x D	Receiving data line
5	GND	GND signal
7	CTS	HW handshake
8	RTS	HW handshake

## 1.2 Connection Plan RS232

### Software Handshake

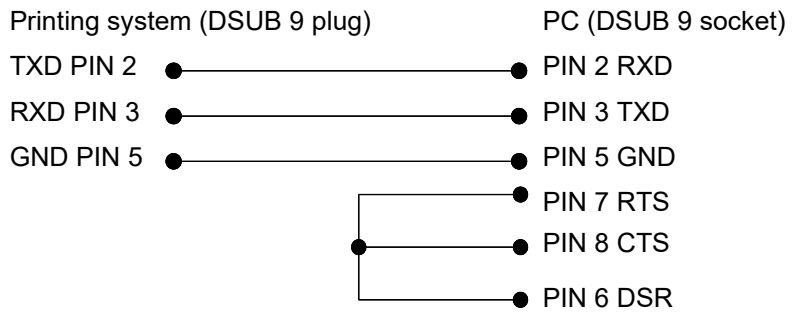
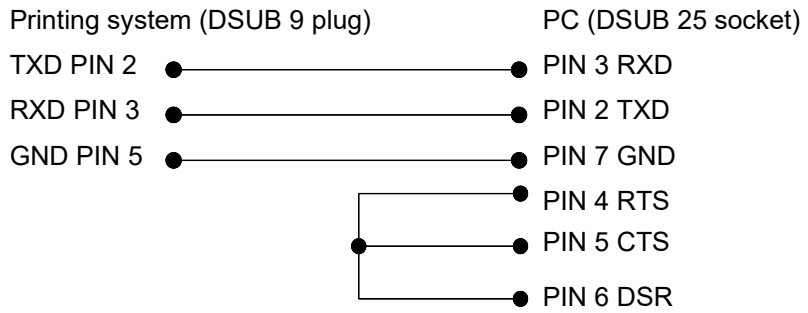

### Hardware Handshake

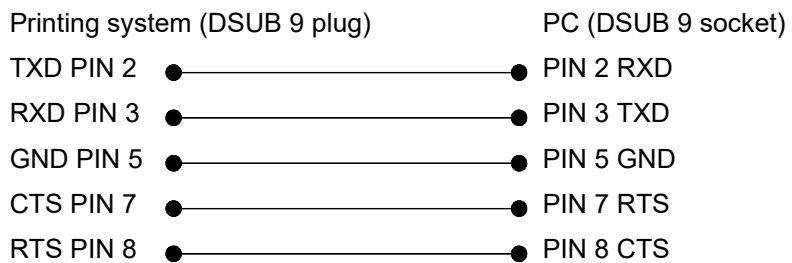
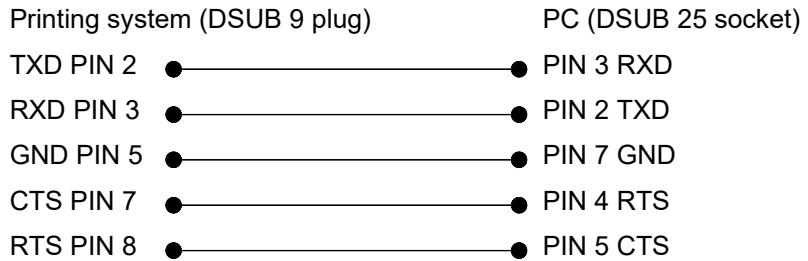

## 2 Parallel Data Transmission

### 2.1 Connection Plan

Signal Pin no.	Signal name	Direction	Function
1	$\overline{\text{STROBE}}$	(Input)	The $\overline{\text{STROBE}}$ signal indicates that data can be received. The impulse width to the receiving line has to be 0,5 $\mu\text{s}$ at least.
2	DATA 0	(Input)	The signals are data bits sent to the direct print module. A HIGH level corresponds to logical 1 and a LOW level to logical 0.
3	DATA 1	(Input)	
4	DATA 2	(Input)	
5	DATA 3	(Input)	
6	DATA 4	(Input)	
7	DATA 5	(Input)	
8	DATA 6	(Input)	
9	DATA 7	(Input)	
10	ACK/	(Output)	An impulse of approx. 12 $\mu\text{s}$ confirms data input for a LOW level and signalizes the further listening watch of the direct print module.
11	BUSY	(Output)	A HIGH level indicates that the direct print module cannot receive any data. On the following conditions the signal HIGH is possible: <ol style="list-style-type: none"> <li>1) for data input (impulse for each sign)</li> <li>2) during a printing process</li> <li>3) in Offline status</li> <li>4) for printing systems failures</li> </ol>
12	PE	(Output)	A HIGH level indicates that paper is used up.
13	SELECT	(Output)	High Online
14	AUTOFEED		
15	FAULT/	(Output)	Signal goes to LOW, in case <ol style="list-style-type: none"> <li>1) the paper is used up</li> <li>2) the direct print module is Offline</li> <li>or</li> <li>3) an error occurs.</li> </ol>
16	INIT/	(Input)	A LOW level initializes the direct print module
17	SELECTIN/	(Input)	A LOW level informs the direct print module to be addressed
18-25	GND		



### 3 Text, Bar Code, Graphic

#### 3.1 Definition of Rotation

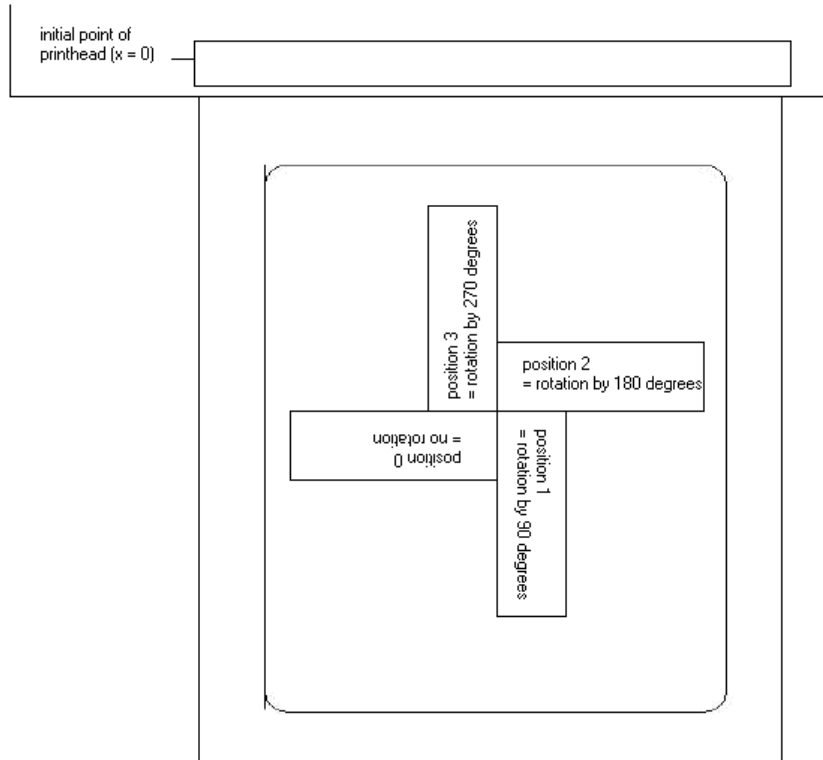

#### 3.2 Definition of Datum Point

The so-called datum point is the relation point for indication of position. In the meantime the datum point is also the point at which the selected object is rotated.

To determine the datum point in the mask sets, the possible datum points are numbered from left top (1) to right bottom (9). The default datum point is left bottom (7). This datum point is also used even if no indication is found in the mask set.

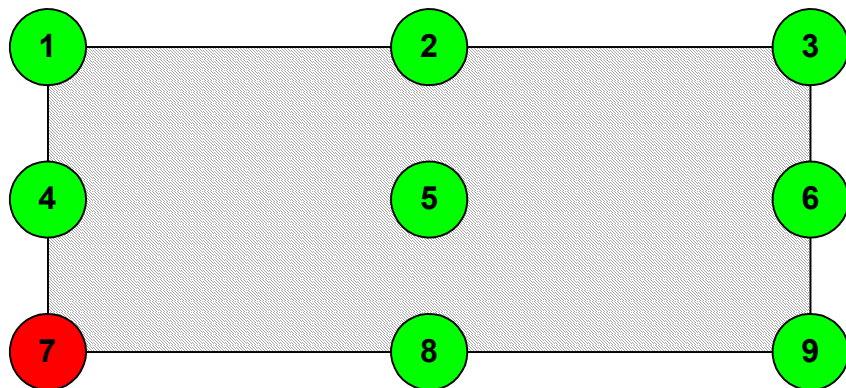





## 4.1 Explication

**x coordinate:** Distance from right layout rim in mm  
Measured from the right layout rim up to the lower left point of the corresponding line

**y coordinate:** Distance from upper layout rim in mm  
Measured from the beginning of the layout down to the lower left point of the corresponding line

### Bitmap fonts (not proportional)

01 = Font 01	0,8 x 1,1 mm	127 characters
02 = Font 02	1,2 x 1,7 mm	255 characters
03 = Font 03	1,8 x 2,6 mm	255 characters
04 = Font 04	4,0 x 5,6 mm	127 characters
05 = Font 05	1,8 x 3,2 mm (descender)	255 characters
06 = Font 06	1,5 x 2,9 mm	127 characters
07 = Font 07	1,2 x 2,2 mm (descender)	255 characters

### Bitmap fonts (proportional)

21 = Font 21	(1,0; 13)	255 characters
22 = Font 22	(1,8; 21)	255 characters
23 = Font 23	(2,6; 31)	255 characters
24 = Font 24	(5,6; 67)	255 characters
28 = Font 28	(4,0; 48)	255 characters
29 = Font 29	(0,8; 9)	255 characters



### NOTICE!

In order to reach best print results it is recommended always to choose the biggest possible font.

### Vector fonts (proportional)

When in mode 'proportional text', the height and width of text have to be entered in mm.  
These values refer to the capital 'M', i.e. the values of other characters are changing in proportion.

### Vector fonts (autoscale)

When in autoscale mode, height and width of text has to be entered in mm.  
The height of the text refers to all capital letters. When using small characters and descenders the height is changing in proportion. When entering the width, the complete file has to be considered. The text will be adjusted automatically, which means that the width of the characters is changing.

## 4.2 Definition of Field Attributes/Field Properties (optional)

### Explanation

Additionally to mask set 'AM[ ] ...' the possibility was created to define further field properties. In order to achieve a high flexibility, the field properties received own names/identifications. Therefore the sequence as well as the number of field properties is free. If necessary, the mask set 'AC[ ]' is transferred additionally to mask set 'AM[ ]' to the direct print module.

### Structure mask set

(SOH)AC[ ]at1=*value*;at2= *value*;...(ETB)

Attribute (at):	Description
BT BW QZ	<b>ITF 14 (see page 22)</b> bearer bar type bearer bar width quiet zone in 1/100 mm
NAME	<b>Field name (see page 14)</b> definition of field name
FN	<b>Field number (see page 18)</b> Free definable field number

This table is constantly extended. The current version is available on demand.

### 4.3 Field Name

#### Application (customized)

When direct print modules are connected to a computer system or machine controls, there is often the requirement that variable data is to be inserted into an existing layout. This data contents come from the superordinate computer system (database) or a machine control (e.g. PLC, scale, ERP system, etc.). Basically, it was always possible to integrate variable data into a 'loaded' layout (mask). The access to certain fields has been effected via the field index, i.e. a consecutive number. This field index is generated by Labelstar Office and can also change with layout changes, whereby the data allocation to the computer system/control is no longer correct.

#### Example

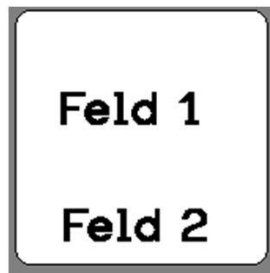

#### Print data

```

...
// TEXT (1/100 mm)
(SOH)AM[1]2405;803;0;1;2;4;1;1;0(ETB)
(SOH)BM[1]Feld 1(ETB)
// TEXT (1/100 mm)
(SOH)AM[2]421;856;0;1;2;4;1;1;0(ETB)
(SOH)BM[2]Feld 2(ETB)
// LINES: 2
...

```

The print data contains the definitions for the two text fields. The field index is always in '[' ]' of the mask or text setting.

If the text field 'Feld 1' is deleted on the layout and then recreated, it gets a new index. In this case '2'. The text field 'Feld 2' gets the index '1'. As a result, an assignment via the field index is used only to a limited extend, without manual post-processing of the layout data.

**Explanation**

As an alternative to the field index, the assignment can also be made via the field name. A change in the field index has no longer any influence, and a changed layout is still filled in the right places with variable data of the computer system/control system.

Labelstar Office: The print data is supplemented by the following line:

(SOH)AC[1]NAME="*Field name*"(ETB)

The field content defined via the text block can be changed by the computer system/control with the following command:

(SOH)BV[*Field name*]Feld 2(ETB)

This results in the following standard procedure for the connection to a high-level control and/or computer system.

**Layout design with Labelstar Office**

The field names are automatically transferred by Labelstar Office.

The screenshot shows the 'Properties' dialog box with the following settings:

- Appearance:**
  - Font: Helvetica Bold, 4
  - Inverted:  No
  - Line spacing: 0.00 mm
  - Text alignment: Left
  - Text color: Black
- Behavior:**
  - Locked:  No
  - Log:  No
  - Printable:  Yes
  - Word wrap:  No
- Data:**
  - Status: OK
  - Text: externally filled
- General:**
  - Name: Field1 (indicated by a green arrow)
- Layout:**
  - Base point: Top left

The desired field name (Field1) is entered in the properties of the text field.

For text fields, a printer-internal font must be used. The device-internal fonts are marked by a printer symbol in the list.

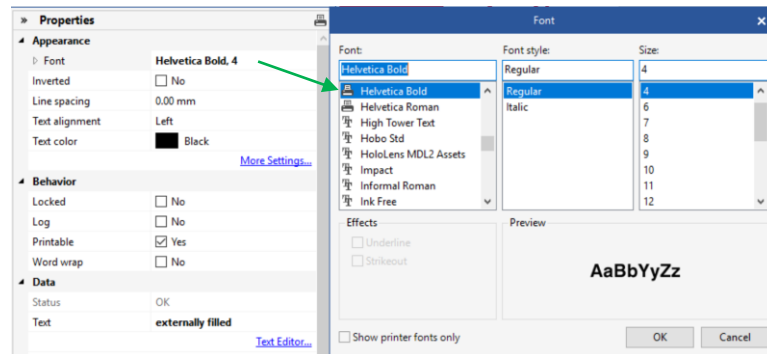

## Export to a print file and save the layout in the external controller

When the layout design is finished, the layout is exported to a print file. For this, Labelstar Office uses the function **File – Export – Create Print Template**.

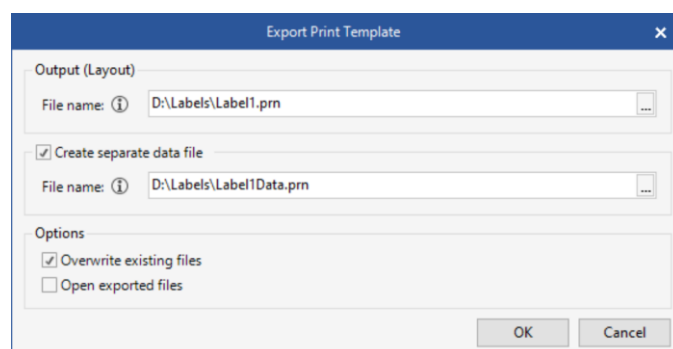
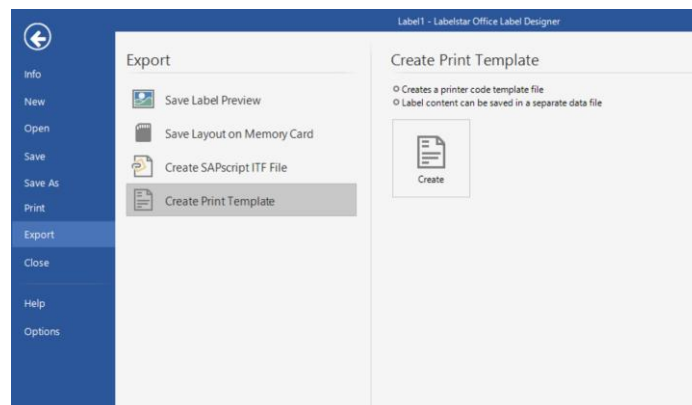

The option **Create separate data file** must be selected, otherwise the line (SOH)**FBC---r-----**(ETB) is included in the print file, which would immediately release a print procedure.

By starting a print procedure, this print file (layout definition / mask definition) is transferred from the controller/computer system to the direct print module first.

### Save the layout on the memory card of the direct print module

As an alternative to 'Export to a print file' the layout is saved on the memory card of the direct print module. For this, the memory card tool from Labelstar Office can be used.

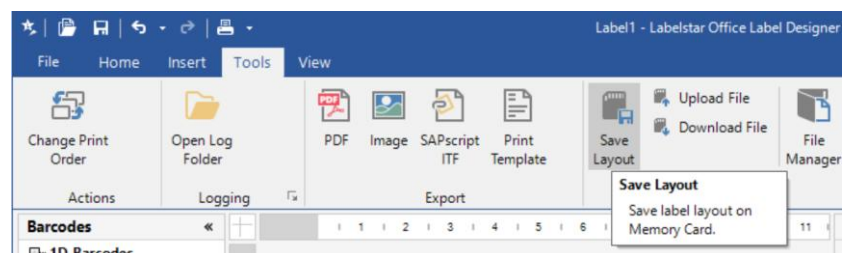

The layout must be called by the controller/computer system **before** filling the variable fields.

The following parameter set is used:

(SOH)**FMA---rfilename**(ETB)

The path name is determined when saving and possibly contains a path.

Example: "A:\Standard\eti1".

### Filling the variable fields by the controller/computer system

The higher-level control can select the variable fields by the field names and set the contents. Subsequently, the print job is restarted.

<b>Example</b>	<b>(SOH)FMB---rfilename(ETB)</b>	Loading the layout from mc
	<b>(SOH)BV[ArtBez]screws(ETB)</b>	Filling the field "ArtBez" with "screws"
	<b>(SOH)BV[ArtNr]123456789(ETB)</b>	Filling the field "ArtNr" with "123456789"
	<b>(SOH)FBC---r------(ETB)</b>	Start printing

#### 4.4 Field Selection by Free Definable Field Number

With the following described attribute, it is possible to assign a free definable field number to a field. This field number does not have to be clear, i.e. several fields can have the same field number. In this way the same field contents can be assigned to different fields.

The following attribute identification is defined:

Attribute: **FN**

Description: free definable field number

After the field number was assigned with AC mask statement,

**(SOH) AC [n] FN=nr (ETB)**

n = field index

nr = free definable field number

it is possible to access to the field and/or the fields with the new BF text statement:

**(SOH) BF [nr] text (ETB)**

nr = field number

text = field contents

<b>Example</b>	<pre>// Assignment of field number field 1 and field 2 (SOH) AM[1]1000;2500;0;4;2;7;400;400;0 (ETB) <b>(SOH) AC [1] FN=100 (ETB)</b> (SOH) AM[2]2000;2500;0;30;2;4000;9;3;0;1 (ETB) <b>(SOH) AC [2] FN=100 (ETB)</b>  // Access to field 1 and field 2 by field number <b>(SOH) BF [100]1234567890 (ETB)</b></pre>
----------------	--



dy	extension in direction Y bitmap fonts                      factor 0...9 vector fonts                        character size in 1/100 mm vector fonts autoscale            field height
dx	extension in direction X bitmap fonts                      factor 0-9 vector fonts                        character size in 1/100 mm vector fonts autoscale            field width
lp	distance between single characters in 1/100 mm
dp	datum point 1 = left top 2 = centre top 3 = right top 4 = left centre 5 = centre centre 6 = right centre 7 = left bottom (default) 8 = centre bottom 9 = right bottom





## 5.4 PDF417

<b>AM[n];x;p:a;d;s;rw;rh;ec;z;dp;c;r</b>	
A	identification for mask set
M	identification for protocol version
n	Field number
y	Y position in 1/100 mm
x	X position in 1/100 mm
p	identification for phantom field 0 = print 1 = no print
a	identification for field type 50 = PDF417
d	rotation 0 = 0° 1 = 90° 2 = 180° 3 = 270°
s	symbol size
rw	relation width
rh	relation height
ec	error correction level 0 - ECC Level = 0 1 - ECC Level = 2 2 - ECC Level = 6 3 - ECC Level = 14 4 - ECC Level = 30 5 - ECC Level = 62 6 - ECC Level = 126 7 - ECC Level = 254 8 - ECC Level = 510
z	style 0 = standard 1 = truncated 2 = naked 3 = bare
dp	datum point 1 = left top 2 = centre top 3 = right top 4 = left centre 5 = centre centre 6 = right centre 7 = left bottom (default) 8 = centre bottom 9 = right bottom
c	number of columns 0 = automatic, 1-30
r	number of rows 0 = automatic, 3-90

## 5.5 MAXICODE

<b>AM[n;y;x;p;a;d;0;sn;ns;m;0;dp</b>	
A	identification for mask set
M	identification for protocol version
n	field number
y	Y position in 1/100 mm
x	X position in 1/100 mm
p	identification for phantom field 0 = print 1 = no print
a	identification for field type 51 = MAXICODE
d	rotation 0 = 0° 1 = 90° 2 = 180° 3 = 270°
0	dummy
sn	symbol number
ns	quantity of symbols
m	mode 2 = Structured Message (US Carrier) 3 = Structured Message (International Carrier) 4 = Default message
0	dummy
dp	datum point 1 = left top 2 = centre top 3 = right top 4 = left centre 5 = centre centre 6 = right centre 7 = left bottom (default) 8 = centre bottom 9 = right bottom

## 5.6 DataMatrix

<b>AM[n;y;x;p;a;d;s;aw;ah;ec;f;dp</b>																															
A	identification for mask set																														
M	identification for protocol version																														
n	field number																														
y	Y position in 1/100 mm																														
x	X position in 1/100 mm																														
p	identification for phantom field 0 = print 1 = no print																														
a	identification for field type 52 = DataMatrix																														
d	rotation 0 = 0° 1 = 90° 2 = 180° 3 = 270°																														
s	symbol size in 1/100 mm																														
aw	relation width																														
ah	relation height																														
ec	Error Correction <table border="0"> <tr> <td>0 - ECC Type = 0</td> <td>ECC Level = 0</td> <td>Overhead = 0 %</td> </tr> <tr> <td>1 - ECC Type = 2*</td> <td>ECC Level = 40</td> <td>Overhead = 33 %</td> </tr> <tr> <td>2 - ECC Type = 3</td> <td>ECC Level = 50</td> <td>Overhead = 25 %</td> </tr> <tr> <td>3 - ECC Type = 6</td> <td>ECC Level = 80</td> <td>Overhead = 33 %</td> </tr> <tr> <td>4 - ECC Type = 8</td> <td>ECC Level = 100</td> <td>Overhead = 50 %</td> </tr> <tr> <td>5 - ECC Type = 9*</td> <td>ECC Level = 110</td> <td>Overhead = 75 %</td> </tr> <tr> <td>6 - ECC Type = 10*</td> <td>ECC Level = 120</td> <td>Overhead = 50 %</td> </tr> <tr> <td>7 - ECC Type = 11*</td> <td>ECC Level = 130</td> <td>Overhead = 67 %</td> </tr> <tr> <td>8 - ECC Type = 12</td> <td>ECC Level = 140</td> <td>Overhead = 75 %</td> </tr> <tr> <td>9 - ECC Type = 26</td> <td>ECC Level = 200</td> <td>Overhead = 0 %</td> </tr> </table>	0 - ECC Type = 0	ECC Level = 0	Overhead = 0 %	1 - ECC Type = 2*	ECC Level = 40	Overhead = 33 %	2 - ECC Type = 3	ECC Level = 50	Overhead = 25 %	3 - ECC Type = 6	ECC Level = 80	Overhead = 33 %	4 - ECC Type = 8	ECC Level = 100	Overhead = 50 %	5 - ECC Type = 9*	ECC Level = 110	Overhead = 75 %	6 - ECC Type = 10*	ECC Level = 120	Overhead = 50 %	7 - ECC Type = 11*	ECC Level = 130	Overhead = 67 %	8 - ECC Type = 12	ECC Level = 140	Overhead = 75 %	9 - ECC Type = 26	ECC Level = 200	Overhead = 0 %
0 - ECC Type = 0	ECC Level = 0	Overhead = 0 %																													
1 - ECC Type = 2*	ECC Level = 40	Overhead = 33 %																													
2 - ECC Type = 3	ECC Level = 50	Overhead = 25 %																													
3 - ECC Type = 6	ECC Level = 80	Overhead = 33 %																													
4 - ECC Type = 8	ECC Level = 100	Overhead = 50 %																													
5 - ECC Type = 9*	ECC Level = 110	Overhead = 75 %																													
6 - ECC Type = 10*	ECC Level = 120	Overhead = 50 %																													
7 - ECC Type = 11*	ECC Level = 130	Overhead = 67 %																													
8 - ECC Type = 12	ECC Level = 140	Overhead = 75 %																													
9 - ECC Type = 26	ECC Level = 200	Overhead = 0 %																													
f	format ID of data 0 - Format ID = 11 (numeric, 2000 characters)* 1 - Format ID = 1 (numeric, 500 characters) 2 - Format ID = 2 (alphabetical, 500 characters) 3 - Format ID = 3 (alphabetical + pointers, 500 characters) 4 - Format ID = 4 (alphanumeric, 500 characters) 5 - Format ID = 5 (7 Bit, 500 characters) 6 - Format ID = 6 (8 Bit, 500 characters) 7 - Format ID = 7 (pre-programmed, 500 characters)* 8 - Format ID = 12 (alphabetical, 2000 characters) 9 - Format ID = 14 (alphanumeric, 2000 characters)																														
dp	datum point 1 = left top 2 = centre top 3 = right top 4 = left centre 5 = centre centre 6 = right centre 7 = left bottom (default) 8 = centre bottom 9 = right bottom																														

\* not supported

## 5.7 GS1 DataMatrix

<b>AM[n;y;x;p;a;d;s;aw;ah;ec;f;dp</b>																															
A	identification for mask set																														
M	identification for protocol version																														
n	field number																														
y	Y position in 1/100 mm																														
x	X position in 1/100 mm																														
p	identification for phantom field 0 = print 1 = no print																														
a	identification for field type 59 = GS1 DataMatrix																														
d	rotation 0 = 0° 1 = 90° 2 = 180° 3 = 270°																														
s	symbol size in 1/100 mm																														
aw	relation width																														
ah	relation height																														
ec	Error Correction <table style="width: 100%; border-collapse: collapse;"> <tr> <td style="width: 33%;">0 - ECC Type = 0</td> <td style="width: 33%;">ECC Level = 0</td> <td style="width: 33%;">Overhead = 0 %</td> </tr> <tr> <td>1 - ECC Type = 2*</td> <td>ECC Level = 40</td> <td>Overhead = 33 %</td> </tr> <tr> <td>2 - ECC Type = 3</td> <td>ECC Level = 50</td> <td>Overhead = 25 %</td> </tr> <tr> <td>3 - ECC Type = 6</td> <td>ECC Level = 80</td> <td>Overhead = 33 %</td> </tr> <tr> <td>4 - ECC Type = 8</td> <td>ECC Level = 100</td> <td>Overhead = 50 %</td> </tr> <tr> <td>5 - ECC Type = 9*</td> <td>ECC Level = 110</td> <td>Overhead = 75 %</td> </tr> <tr> <td>6 - ECC Type = 10*</td> <td>ECC Level = 120</td> <td>Overhead = 50 %</td> </tr> <tr> <td>7 - ECC Type = 11*</td> <td>ECC Level = 130</td> <td>Overhead = 67 %</td> </tr> <tr> <td>8 - ECC Type = 12</td> <td>ECC Level = 140</td> <td>Overhead = 75 %</td> </tr> <tr> <td>9 - ECC Type = 26</td> <td>ECC Level = 200</td> <td>Overhead = 0 %</td> </tr> </table>	0 - ECC Type = 0	ECC Level = 0	Overhead = 0 %	1 - ECC Type = 2*	ECC Level = 40	Overhead = 33 %	2 - ECC Type = 3	ECC Level = 50	Overhead = 25 %	3 - ECC Type = 6	ECC Level = 80	Overhead = 33 %	4 - ECC Type = 8	ECC Level = 100	Overhead = 50 %	5 - ECC Type = 9*	ECC Level = 110	Overhead = 75 %	6 - ECC Type = 10*	ECC Level = 120	Overhead = 50 %	7 - ECC Type = 11*	ECC Level = 130	Overhead = 67 %	8 - ECC Type = 12	ECC Level = 140	Overhead = 75 %	9 - ECC Type = 26	ECC Level = 200	Overhead = 0 %
0 - ECC Type = 0	ECC Level = 0	Overhead = 0 %																													
1 - ECC Type = 2*	ECC Level = 40	Overhead = 33 %																													
2 - ECC Type = 3	ECC Level = 50	Overhead = 25 %																													
3 - ECC Type = 6	ECC Level = 80	Overhead = 33 %																													
4 - ECC Type = 8	ECC Level = 100	Overhead = 50 %																													
5 - ECC Type = 9*	ECC Level = 110	Overhead = 75 %																													
6 - ECC Type = 10*	ECC Level = 120	Overhead = 50 %																													
7 - ECC Type = 11*	ECC Level = 130	Overhead = 67 %																													
8 - ECC Type = 12	ECC Level = 140	Overhead = 75 %																													
9 - ECC Type = 26	ECC Level = 200	Overhead = 0 %																													
f	format ID of data 0 - Format ID = 11 (numeric, 2000 characters)* 1 - Format ID = 1 (numeric, 500 characters) 2 - Format ID = 2 (alphabetical, 500 characters) 3 - Format ID = 3 (alphabetical + pointers, 500 characters) 4 - Format ID = 4 (alphanumeric, 500 characters) 5 - Format ID = 5 (7 Bit, 500 characters) 6 - Format ID = 6 (8 Bit, 500 characters) 7 - Format ID = 7 (pre-programmed, 500 characters)* 8 - Format ID = 12 (alphabetical, 2000 characters) 9 - Format ID = 14 (alphanumeric, 2000 characters)																														
dp	datum point 1 = left top 2 = centre top 3 = right top 4 = left centre 5 = centre centre 6 = right centre 7 = left bottom (default) 8 = centre bottom 9 = right bottom																														

\* not supported

## 5.8 CODABLOCK F

<b>AM[n]y;x;p;a;d;h;nc;nl;m;s;dp</b>	
A	identification for mask set
M	identification for protocol version
n	field number
y	Y position in 1/100 mm
x	X position in 1/100 mm
p	identification for phantom field 0 = printout 1 = np printout
a	identification for field type 53 = CODABLOCK F
d	rotation 0 = 0° 1 = 90° 2 = 180° 3 = 270°
h	line height in symbol
nc	quantity of characters/line
nl	quantity of lines
m	mode
s	module size
dp	datum point 1 = left top 2 = centre top 3 = right top 4 = left centre 5 = centre centre 6 = right centre 7 = left bottom (default) 8 = centre bottom 9 = right bottom

### 5.9 GS1 DataBar (RSS Code)

<b>AM[n];x;p;a;d;s;m;k;t;0;dp</b>	
A	identification for mask set
M	identification for protocol version
n	field number
y	Y position in 1/100 mm
x	X position in 1/100 mm
p	identification for phantom field 0 = print 1 = no print
a	identification for field type 54 = GS1 DataBar (RSS)
d	rotation 0 = 0° 1 = 90° 2 = 180° 3 = 270°
s	number of segments per line [2...22]
m	module width [1 ...12]
k	separator height [1,2]
t	symbol type 1 = GS1 DataBar Omnidirectional (RSS-14) 2 = GS1 DataBar Truncated (RSS-14 Truncated) 3 = GS1 DataBar Stacked (RSS-14 Stacked) 4 = GS1 DataBar Stacked Omnidirectional (RSS-14 Stacked Omnidirectional) 5 = GS1 DataBar Limited (RSS Limited) 6 = GS1 DataBar Expanded (RSS Expanded)
0	not used
dp	datum point 1 = left top 2 = centre top 3 = right top 4 = left centre 5 = centre centre 6 = right centre 7 = left bottom (default) 8 = centre bottom 9 = right bottom

### 5.10 QR Code

<b>AM[n];x;p;a;d;mo;cs;ms;cw;ec;dp</b>	
A	identification for mask set
M	identification for protocol version
n	field number
y	Y position in 1/100 mm
x	X position in 1/100 mm
p	identification for phantom field 0 = print 1 = no print
a	identification for field type 57 = QR Code
d	rotation 0 = 0° 1 = 90° 2 = 180° 3 = 270°
mo	code model 1 = Code Model 1 2 = Code Model 2
cs	character set N = numeric A = alphanumeric B = 8-bit byte K = kanji
ms	masking -1 = auto 0-7 = mask x 8 = no masking
cw	line width in 1/100 mm per module possible values: 0-800
ec	error correction (restoring capacity) L = 7 % M = 15 % Q = 25 % H = 30 %
dp	datum point 1 = left top 2 = centre top 3 = right top 4 = left centre 5 = centre centre 6 = right centre 7 = left bottom (default) 8 = centre bottom 9 = right bottom

### 5.11 Aztec Code

<b>AM[n]y;x;p;a;d;h;f;ec;m;0;dp</b>																																							
A	identification for mask set																																						
M	identification for protocol version																																						
n	field number																																						
y	Y position in 1/100 mm																																						
x	X position in 1/100 mm																																						
p	identification for phantom field 0 = print 1 = no print																																						
a	identification for field type 61 = Aztec Code																																						
d	rotation 0 = 0° 1 = 90° 2 = 180° 3 = 270°																																						
h	symbol size in 1/100 mm (max 1 cm)																																						
f	format <table style="width: 100%; border: none;"> <tr> <td>0 = Auto</td> <td>19 = C79xC79</td> </tr> <tr> <td>1 = C15xC15 Compact</td> <td>20 = C83xC83</td> </tr> <tr> <td>2 = C19xC19 Compact</td> <td>21 = C87xC87</td> </tr> <tr> <td>3 = C23xC23 Compact</td> <td>22 = C91xC91</td> </tr> <tr> <td>4 = C27xC27 Compact</td> <td>23 = C95xC95</td> </tr> <tr> <td>5 = C19xC19</td> <td>24 = C101xC101</td> </tr> <tr> <td>6 = C23xC23</td> <td>25 = C105xC105</td> </tr> <tr> <td>7 = C27xC27</td> <td>26 = C109xC109</td> </tr> <tr> <td>8 = C31xC31</td> <td>27 = C113xC113</td> </tr> <tr> <td>9 = C37xC37</td> <td>28 = C117xC117</td> </tr> <tr> <td>10 = C41xC41</td> <td>29 = C121xC121</td> </tr> <tr> <td>11 = C45xC45</td> <td>30 = C125xC125</td> </tr> <tr> <td>12 = C49xC49</td> <td>31 = C131xC131</td> </tr> <tr> <td>13 = C53xC53</td> <td>32 = C135xC135</td> </tr> <tr> <td>14 = C57xC57</td> <td>33 = C139xC139</td> </tr> <tr> <td>15 = C61xC61</td> <td>34 = C143xC143</td> </tr> <tr> <td>16 = C67xC67</td> <td>35 = C147xC147</td> </tr> <tr> <td>17 = C71xC71</td> <td>36 = C151xC151</td> </tr> <tr> <td>18 = C75xC75</td> <td></td> </tr> </table>	0 = Auto	19 = C79xC79	1 = C15xC15 Compact	20 = C83xC83	2 = C19xC19 Compact	21 = C87xC87	3 = C23xC23 Compact	22 = C91xC91	4 = C27xC27 Compact	23 = C95xC95	5 = C19xC19	24 = C101xC101	6 = C23xC23	25 = C105xC105	7 = C27xC27	26 = C109xC109	8 = C31xC31	27 = C113xC113	9 = C37xC37	28 = C117xC117	10 = C41xC41	29 = C121xC121	11 = C45xC45	30 = C125xC125	12 = C49xC49	31 = C131xC131	13 = C53xC53	32 = C135xC135	14 = C57xC57	33 = C139xC139	15 = C61xC61	34 = C143xC143	16 = C67xC67	35 = C147xC147	17 = C71xC71	36 = C151xC151	18 = C75xC75	
0 = Auto	19 = C79xC79																																						
1 = C15xC15 Compact	20 = C83xC83																																						
2 = C19xC19 Compact	21 = C87xC87																																						
3 = C23xC23 Compact	22 = C91xC91																																						
4 = C27xC27 Compact	23 = C95xC95																																						
5 = C19xC19	24 = C101xC101																																						
6 = C23xC23	25 = C105xC105																																						
7 = C27xC27	26 = C109xC109																																						
8 = C31xC31	27 = C113xC113																																						
9 = C37xC37	28 = C117xC117																																						
10 = C41xC41	29 = C121xC121																																						
11 = C45xC45	30 = C125xC125																																						
12 = C49xC49	31 = C131xC131																																						
13 = C53xC53	32 = C135xC135																																						
14 = C57xC57	33 = C139xC139																																						
15 = C61xC61	34 = C143xC143																																						
16 = C67xC67	35 = C147xC147																																						
17 = C71xC71	36 = C151xC151																																						
18 = C75xC75																																							
ec	error correction (only if format = 0) 1 = 10 % 2 = 23 % 3 = 36 % 4 = 50 %																																						
m	mode 0 = data 1 = runes (figures 0-255) 2 = Unicode (8 Bit ASCII) 3 = GS1 (not yet available)																																						
0	dummy																																						
dp	datum point 1 = left top 2 = centre top 3 = right top 4 = left centre 5 = centre centre 6 = right centre 7 = left bottom (default) 8 = centre bottom 9 = right bottom																																						

## 5.12 Rectangle

<b>AM[n]y;x;p;a;h;b;s;m;dp</b>	
A	identification for mask set
M	identification for protocol version
n	field number
y	Y position in 1/100 mm
x	X position in 1/100 mm
p	identification for phantom field 0 = print 1 = no print
a	identification for field type 10 = rectangle
h	rectangle height in 1/100 mm
b	rectangle height in 1/100 mm
s	line width in 1/100 mm
m	line type; 1 digit
dp	datum point 1 = left top 2 = centre top 3 = right top 4 = left centre 5 = centre centre 6 = right centre 7 = left bottom (default) 8 = centre bottom 9 = right bottom

## 5.13 Line

<b>AM[n]y;x;p;a;d;l;s;m;dp</b>	
A	identification for mask set
M	identification for protocol version
n	field number
y	Y position in 1/100 mm
x	X position in 1/100 mm
p	identification for phantom field 0 = printout 1 = no printout
a	identification for field type 11 = line
d	rotation 0 = horizontal 1 = vertical
l	length in 1/100 mm
s	line width in 1/100 mm
m	line type; 1 digit
dp	datum point 1 = left top 2 = centre top 3 = right top 4 = left centre 5 = centre centre 6 = right centre 7 = left bottom (default) 8 = centre bottom 9 = right bottom

### 5.14 Internal Graphic

<b>AM[n]y;x;p;a;d;dy;dx;dp</b>	
A	identification for mask set
M	identification for protocol version
n	field number
y	Y position in 1/100 mm
x	X position in 1/100 mm
P	identification for phantom field 0 = print 1 = no print
a	identification for field type 3 = internal graphic
d	rotation 0 = 0° 1 = 90° 2 = 180° 3 = 270°
dy	rotation in direction Y
dx	rotation in direction X
dp	datum point 1 = left top 2 = centre top 3 = right top 4 = left centre 5 = centre centre 6 = right centre 7 = left bottom (default) 8 = centre bottom 9 = right bottom

## 6 Text Set

<b>BM[n]text</b>	
B	identification for text set
M	identification for extended protocol
n	field number
text	data contents, text

<b>BV[n]text</b>	
B	identification for text set
V	identification for selection by field name
n	field name
text	data contents, text

<b>BF[n]text</b>	
B	identification for text set
F	identification for selection by free definable field number
n	field number
text	data contents, text

## 6.1 Examples

### Mask set

Mask statement	[SOH]AM[1]2000;4000;0;1;0;2;1;1;0[ETB]
field number	_____
y position 20 mm	_____
x position 40 mm	_____
no phantom field	_____
bitmap font	_____
position 0	_____
font 2	_____
extension in y direction 1	_____
extension in x direction 1	_____
no blank pixel	_____

### Texts set

Text statement	[SOH]BM[1]this is a test [ETB]
field number 1	_____
text "this is a test"	_____

### Text set with variable definition:

[SOH]BM[125]=CN(0,0,3,1,1)000[ETB]

### Example layout

ASCII data	Identification
⊗AM[1]3600;4600;0;33;0;1500;0;4;1;1⊕ <sup>C<sub>R</sub></sup> ⊕ <sup>L<sub>F</sub></sup>	mask set for bar code
⊗BM[1]4444444444444⊕ <sup>C<sub>R</sub></sup> ⊕ <sup>L<sub>F</sub></sup>	appropriate text set
⊗AM[2]600;4700;0;4;0;1;300;200;24⊕ <sup>C<sub>R</sub></sup> ⊕ <sup>L<sub>F</sub></sup>	five mask sets vector font / proportional font
⊗AM[3]600;3100;0;4;0;1;400;300;24⊕ <sup>C<sub>R</sub></sup> ⊕ <sup>L<sub>F</sub></sup>	
⊗AM[4]1100;4700;0;4;0;1;400;300;24⊕ <sup>C<sub>R</sub></sup> ⊕ <sup>L<sub>F</sub></sup>	
⊗AM[5]1800;4700;0;4;0;1;300;200;24⊕ <sup>C<sub>R</sub></sup> ⊕ <sup>L<sub>F</sub></sup>	
⊗AM[6]1900;3700;0;4;0;1;600;400;24⊕ <sup>C<sub>R</sub></sup> ⊕ <sup>L<sub>F</sub></sup>	
⊗BM[2]Art.Nr. ⊕ <sup>C<sub>R</sub></sup> ⊕ <sup>L<sub>F</sub></sup>	five appropriate text sets
⊗BM[3]44444⊕ <sup>C<sub>R</sub></sup> ⊕ <sup>L<sub>F</sub></sup>	
⊗BM[4]Artikelbezeichnung⊕ <sup>C<sub>R</sub></sup> ⊕ <sup>L<sub>F</sub></sup>	
⊗BM[5]EUR⊕ <sup>C<sub>R</sub></sup> ⊕ <sup>L<sub>F</sub></sup>	
⊗BM[6]99,-- ⊕ <sup>C<sub>R</sub></sup> ⊕ <sup>L<sub>F</sub></sup>	
⊗FBA000r06000000⊕	number of lines
⊗FBBA00r00001000⊕	number of items
⊗FBC000r00000000⊕	start

# : graphic data in PCX format

⊗: SOH (1<sub>hex</sub> bzw 5E<sub>hex</sub>)

⊕: ETB (17<sub>hex</sub> bzw. 5F<sub>hex</sub>)

<sup>C<sub>R</sub></sup>: CarriageReturn (0D<sub>hex</sub>)

<sup>L<sub>F</sub></sup>: LineFeed (0A<sub>hex</sub>)



- It is recommended to observe that directly after the final sign (ETB) no separator res. fill character such as  $C_R L_F$  is indicated.
- The direct print module supports the following PCX versions: 5, 3, 2 and 0.
- It is necessary that the corresponding PCX-file is available as monochrome (black/white).
- The graphic has to be available in the original size as the direct print module is not able to change the size by itself.

**NOTICE!**

Before print start, indicated by parameter set 'FBC', the definition of field number, lines and pieces has to be effected via the parameter sets (FBA res. FBB).

### 7.3 Example PCX File

-\*\*\* PCX\_GRAPHIC-INFO \*\*\*-

⊗AX0010015300100941⊕#####	
⊗AM[1]3600;4600;0;33;0;1500;0;4;1;1⊕ $C_R L_F$	mask set for bar code
⊗BM[1]444444444444⊕ $C_R L_F$	appropriate text set
⊗AM[2]600;4700;0;4;0;1;300;200;24⊕ $C_R L_F$	five mask set vector font / proportional font
⊗AM[3]600;3100;0;4;0;1;400;300;24⊕ $C_R L_F$	
⊗AM[4]1100;4700;0;4;0;1;400;300;24⊕ $C_R L_F$	
⊗AM[5]1800;4700;0;4;0;1;300;200;24⊕ $C_R L_F$	
⊗AM[6]1900;3700;0;4;0;1;600;400;24⊕ $C_R L_F$	
⊗BM[2]Art.Nr. ⊕ $C_R L_F$	five appropriate text sets
⊗BM[3]444444⊕ $C_R L_F$	
⊗BM[4]Artikelbezeichnung⊕ $C_R L_F$	
⊗BM[5]EUR⊕ $C_R L_F$	
⊗BM[6]99,-- ⊕ $C_R L_F$	
⊗FBA00r06000000⊕	set number of lines (FBA...)
⊗FBBA00r00001000⊕	set quantity (FBBA...)
⊗FBC000r00000000⊕	start print order (FBC...)

# : Grafikdaten im PCX Format

⊗: SOH (1<sub>hex</sub> bzw. 5E<sub>hex</sub>)

⊕: ETB (17<sub>hex</sub> bzw. 5F<sub>hex</sub>)

$C_R$ : CarriageReturn (0D<sub>hex</sub>)

$L_F$ : LineFeed (0A<sub>hex</sub>)

## 8 Variables

### 8.1 Set Structure

SOH	BM	[n]	=	v	v	(	p1	p2	p...	pn	)	t1	t2	t...	t70	ETB
-----	----	-----	---	---	---	---	----	----	------	----	---	----	----	------	-----	-----

= start of function  
 vv variable type  
   SC link field  
   CN counter  
   CC extended counter  
   CL date/time  
   CU currency variable  
   SH shift variable  
   MD memory card data  
 ( start of variable parameter block  
 p1...pn variable parameter  
 ) end of variable parameter block



#### NOTICE!

In case you want to print a text which corresponds exactly to the variable definition then you have to place '!' before.

SOH	BM	[n]	!	=	v	v	(	p1	p2	p...	pn	)	t1	t2	t...	t70	ETB
-----	----	-----	---	---	---	---	---	----	----	------	----	---	----	----	------	-----	-----

### 8.2 Link Field

SOH	BM	[n]	=	S	C	(	p1	;	p2	;	p...	;	pn	)	t1	t2	t...	t70	ETB
-----	----	-----	---	---	---	---	----	---	----	---	------	---	----	---	----	----	------	-----	-----

= SC identification of link field  
 p1...pn identification of link elements (field number or constant text)  
   field number is entered without leading '0'  
   constant text is included in " but these marks are not printed



#### NOTICE!

Reference fields can be constant text or variables but no link fields.

#### Example

=SC(1;2;3) --> Printout: Field1Field2Field3

=SC(1;"constant";2) --> Printout: Field1constantField2

### 8.3 Counter

SOH	BM	[n]	=	C	N	(	t	;	m	;	c	;	+/-	s	;	i	;	h	;	r	)	t1	t2	t...	t70	ETB
-----	----	-----	---	---	---	---	---	---	---	---	---	---	-----	---	---	---	---	---	---	---	---	----	----	------	-----	-----

= CN identification counter

t type of counter  
 0 numerical  
 1 letters only  
 2...36 radix, base of the counter

m function mode  
 0 standard  
 1 return to start value  
 2 enter the start value at the beginning of printing  
 (default = existing start value)  
 3 enter the start value at the beginning of printing  
 (default = last final number)  
 4 reset start value at cycle end  
 (only for DPM IIIi)  
 5 reset start value by I/O signal  
 6 time-controlled resetting  
 7 time-controlled resetting with input of initial value  
 (default = last final value)

c digit where the numbering starts counting

+/- direction  
 + adding  
 - subtracting

s step width

i update interval  
 (number of layouts with identical number)

h time by which the counter is reset (function mode 6 and 7)  
 in format 'HH:MM'  
 e.g. 00:00 = reset counter at 0:00  
 (optional, only for function mode 6 and 7)

r reset value  
 (optional, only for function mode 6 and 7; default = text  
 and/or initial value)  
**Limitation:**  
 The time-controlled resetting of counter variable is only  
 effected in case of an active print order. If a print order is  
 cancelled before the specified time and afterwards again  
 restarted then no resetting of counter value is effected.

t1, t2, ... text res. start value of counter

#### Example:

Input: =CN(10;7;4;+1;1;06:00;0001)1234

The enquiry for the initial value is effected at print start and  
 at 6:00 the counter variable is reset to value 0001.

## 8.4 Extended Counter

SOH	BM	[n]	=	C	C	(	+/-	s	;	i	;	m	;	z	;	n	;	x	)	t	ETB
-----	----	-----	---	---	---	---	-----	---	---	---	---	---	---	---	---	---	---	---	---	---	-----

= CC	identification of numeric counter
+/-	direction
	+ counter adding
	- counter subtracting
s	step width
i	update interval (number of layouts with identical number)
m	function mode
	0 standard
	1 return to start value
	2 enter the start value at the beginning of printing (default = existing start value)
	3 enter the start value at the beginning of printing (default = last final number)
	4 reset start value at cycle end (only for DPM IIIi)
	5 set min. / max. value
	6 set start value
	7 print end
z	leading zeros
	0 no leading zeros
	1 printout with leading zeros
n	minimum value (max. -999999999)
x	maximum value (max. 999999999)
t	start value (the number of digits determines the format for the printout with leading zeros (max. 999999999)

Example:

Input: =CC(+1;2;5;0;1,999)0050

Printout: 50, 51,...999, 1, 2, ...

## 8.5 Date and Time

```
SOHBM[n]=CL(m;d;i;n;c;mo;pd;pm;md;mm;rw;ws)t1t...t70ETB
```

= CL identification date/time  
 m month offset to the actual date  
 d day offset to the actual date  
 i update interval  
 (0 = at the beginning of a print order, 1 = each layout)

### Optional parameters

n minute offset of the actual time  
 (negative entry/value possible)  
 c correction month overflow  
 (0 = change to the next month, 1 = remain in current month)

### Optional parameters for BBE date

mo input mode  
 0: standard; display current date of real time clock  
 1: display calculated date, modification possible  
 2: display calculated date, no modification possible  
 pd max. positive correction days  
 pm max. positive correction months  
 md max. negative correction days  
 mm max. negative correction months

### Optional parameters for rounded date

rw rounded weekday: 1 = Sunday ... 7 = Saturday; 0 = no rounding  
 ws start of week, format: "D-HH:MM",  
 e.g. 1-00:00 = Sunday, 0:00 Uhr

### Example

Actual date as per Real Time Clock: 08.12.

Input: =CL(0;0;0)<DD.MO.YY> Printout:08.12.  
 Input: =CL(2;1;0)<DD.MO.YY> Printout: 09.02.

### Example for BBE date

Input: =CL (0;0;0;0;0;1;3;2;3;2)<DD.MO.YY>  
 At print start the calculated date is displayed at the printing system and can be modified (+/- 3 days and +/- 2 months):

Display: ID\_1 DD:MO:YY  
 08.12.11

### Example for rounded date

The beginning of the week is on Sunday (08.12.) at 00:00. The date of Monday should be printed the whole week.

Input: =CL(0;0;0;0;0;0;0;0;0;2;1-00:00)<DD.MO.YY>

Current date	Rounded date
07.12. 23:59:59	02.12.
08.12. 00:00:00	09.12
09.12.	09.12.
14.12. 23:59:59	09.12.
15.12. 00:00:00	16.12.

## 8.6 Format Identifier (Date & Time)

Standard format	
HH	Hours 2-digit (24 hours)
<b>HE</b>	<b>Hours 2-digit (12 hours)</b>
MI	Minutes 2-digit
SS	Seconds 2-digit
<b>AM</b>	<b>AM/PM output</b>
DD	Day 2-digit
MO	Month 2-digit
YYYY	Year 4-digit
YY	Year 2-digit
Y	Year 1-digit
WW	Calendar week
DW	Day of week (Sunday = 0)
DW1	Day of week (Sunday = 1)
DwX	Day of week An arbitrary ASCII character can be used for x, from which it is counted consecutively
DOWxxxxxxx	Day of week - variable For x, any ASCII character can be used. The first ,x' denominates Sunday, the next denominates Monday and so on until Saturday For each weekday a character must be created
DOY	Day of year 3-digit (First January = 1)
DY	Day of year 3-digit (First January = 0)
Examples	
DD.MO.YY	22.01.10
MO/DD/YYYY	01/22/2010
YY-MO-DD	10-01-22
YYMODD	100122

The format identifier 'HE' and 'AM'/'am'/'Am' are supplemented. Therefore the output of hours in 12-hours mode is possible. By the additional output of format identifier 'AM' the output of time in american/english format is possible.

### Example

```
=CL(0;0;0;0)<HH:MI:SS>      --> 15:30:00
=CL(0;0;0;0)<HE:MI:SS>      --> 03:30:00
=CL(0;0;0;0)<HE:MI:SS AM>   --> 03:30:00 PM
=CL(0;0;0;0)<HE:MI:SS am>   --> 03:30:00 pm
=CL(0;0;0;0)<HE:MI:SS Am>   --> 03:30:00 p.m.
```

By separating the output of time and AM/PM output in 2 text fields, also the following output format is possible:  
--> 03:30:00 pm

<b>Extended format</b>	
XMO	Name of month short
XSO	Name of month long
XSD	Weekday short
XLD	Weekday long
For X you can enter the country identification of desired language	
C = Canadian D = Danish E = English F = French G = German I = Italian N = Dutch O = Norwegian S = Spanish U = Finnish W = Swedish	
<b>Examples:</b>	
DD.EMO.YY	22.JAN.10
DD.ESO YYYY	22. January 2010
ELD,DD.GMO.YY	Friday, 22. JAN.10
ESD,DD.MO.YY	FR, 22.01.10

**Extended format - XMO**

<b>C</b>	JA	FE	MR	AL	MA	JN	JL	AU	SE	OC	NO	DE
<b>D</b>	JAN	FEB	MAR	APR	MAJ	JUN	JUL	AUG	SEP	OKT	NOV	DEC
<b>E</b>	JAN	FEB	MAR	APR	MAY	JUN	JUL	AUG	SEP	OCT	NOV	DEC
<b>F</b>	JAN	FEV	MAR	AVR	MAI	JUIN	JUIL	AOU	SEP	OCT	NOV	DEC
<b>G</b>	JAN	FEB	MRZ	APR	MAI	JUN	JUL	AUG	SEP	OKT	NOV	DEZ
<b>I</b>	GEN	FEB	MAR	APR	MAG	GIU	LUG	AGO	SET	OTT	NOV	DIC
<b>N</b>	JAN	FEB	MRT	APR	MEI	JUN	JUL	AUG	SEP	OKT	NOV	DEC
<b>O</b>	JAN	FEB	MAR	APR	MAI	JUN	JUL	AUG	SEP	OKT	NOV	DES
<b>S</b>	ENE	FEB	MAR	ABR	MAY	JUN	JUL	AGO	SEP	OCT	NOV	DIC
<b>U</b>	TAM	HEL	MAA	HUH	TOU	KES	HEI	ELO	SYU	LOK	MAR	JOU
<b>W</b>	JAN	FEB	MAR	APR	MAJ	JUN	JUL	AUG	SEP	OKT	NOV	DEC

**Extended format - XSO**

<b>C</b>	January	February	March	April	May	June
<b>D</b>	Januar	Februar	Marts	April	Maj	Juni
<b>E</b>	January	February	March	April	May	June
<b>F</b>	Janvier	Février	Mars	Avril	Mai	Juin
<b>G</b>	Januar	Februar	Maerz	April	Mai	Juni
<b>I</b>	Gennaio	Febbraio	Marzo	Aprile	Maggio	Giugno
<b>N</b>	Januari	Februari	Maart	April	Mei	Juni
<b>O</b>	Januar	Februar	Mars	April	Mai	Juni
<b>S</b>	Enero	Febrero	Marzo	Abril	Mayo	Junio
<b>U</b>	Tammikuu	Helmikuu	Maaliskuu	Huhtikuu	Toukokuu	Kesaekuu
<b>W</b>	Januari	Februari	Mars	April	Maj	Juni

<b>C</b>	July	August	September	October	November	December
<b>D</b>	Juli	August	September	Oktober	November	December
<b>E</b>	July	August	September	October	November	December
<b>F</b>	Juillet	Août	Septembre	Octobre	Novembre	Décembre
<b>G</b>	Juli	August	September	Oktober	November	Dezember
<b>I</b>	Luglio	Agosto	Settembre	Ottobre	Novembre	Dicembre
<b>N</b>	Juli	Augustus	September	Oktober	November	December
<b>O</b>	Juli	August	September	Oktober	November	Desember
<b>S</b>	Julio	Agosto	Septiembre	Octubre	Noviembre	Diciembre
<b>U</b>	Heinaekuu	Elokuu	Syyskuu	Lokakuu	Marraksuu	Joulukuu
<b>W</b>	Juli	Augusti	September	Oktober	November	December

**Extended format - XSD**

<b>C</b>	SUN	MON	TUE	WED	THU	FRI	SAT
<b>D</b>	SO	MA	TI	ON	TO	FR	LO
<b>E</b>	SUN	MON	TUE	WED	THU	FRI	SAT
<b>F</b>	DIM	LUN	MAR	MER	JEU	VEN	SAM
<b>G</b>	SO	MO	DI	MI	DO	FR	SA
<b>I</b>	DOM	LUN	MAR	MER	GIO	VEN	SAB
<b>N</b>	ZO	MA	DI	WO	DO	VR	ZA
<b>O</b>	SO	MA	TI	ON	TO	FR	LO
<b>S</b>	DOM	LUN	MAR	MIE	JUE	VIE	SAB
<b>U</b>	SU	MA	TI	KE	TO	PE	LA
<b>W</b>	SO	LA	TI	ON	TO	FR	LO

**Extended format - XLD**

<b>C</b>	Sunday	Monday	Tuesday	Wednesday	Thursday	Friday	Saturday
<b>D</b>	Søndag	Mandag	Tirsdag	Onsdag	Torsdag	Fredag	Lørdag
<b>E</b>	Sunday	Monday	Tuesday	Wednesday	Thursday	Friday	Saturday
<b>F</b>	Dimanche	Lundi	Mardi	Mercredi	Jeudi	Vendredi	Samedi
<b>G</b>	Sonntag	Montag	Dienstag	Mittwoch	Donnerstag	Freitag	Samstag
<b>I</b>	Domenica	Lunedì	Martedì	Mercoledì	Giovedì	Venerdì	Sabato
<b>N</b>	Zondag	Maandag	Dinsdag	Woensdag	Donderdag	Vrijdag	Zaterdag
<b>O</b>	Søndag	Mandag	Tirsdag	Onsdag	Torsdag	Fredag	Lørdag
<b>S</b>	Domingo	Lunes	Martes	Miércoles	Jueves	Viernes	Sábado
<b>U</b>	Sunnuntai	Maanantai	Tiistai	Keski-viikko	Torstai	Perjantai	Lauantai
<b>W</b>	Söndag	Måndag	Tisdag	Onsdag	Torsdag	Fredag	Lördag

## 8.7 Currency Variable

SOH	BM	[n]	=	C	U	(	a	;	b	;	c	;	d	;	e	;	f	;	g	)	t1	t2	t...	t70	ETB
-----	----	-----	---	---	---	---	---	---	---	---	---	---	---	---	---	---	---	---	---	---	----	----	------	-----	-----

= CU Signification of variable Euro

a ANSI-Code of thousand separator as decimal figure

b ANSI-Code of comma separator as decimal figure

c Quantity of numbers after the comma as decimal figure

d Operand A Before the processing the variable Euro

e Operand B calculates the term

f Operand C  $\frac{A \times B}{C}$

g Rounding format

t1, t2, ... Format string, is indicated by "< >"

### Example:

In case the contents of field 20 has to be converted from USD into EUR the definition of variable for the user defined format is as follows:

B01 '=CU(46;44;2;20;"1,0";"0,68861";"0,01")Result: <>Euro'

B20 1.250,44 USD

**Printout:** 1.250,44 USD

Result: 1.815,89 Euro'

---

\* 1 USD = 0,68861 Euro (11.01.2010)

## 8.8 Shift Variable

```
SOH BM [n] = S H ( ) t1 t2 t... t70 ETB
```

= SH identification of shift variable



### NOTICE!

The shift variable did not need any parameters. The settings for the output are defined with the corresponding parameter sets. (see above)

### Beispiel

The shift times are defined: 00:00 - 11:59 "Shift1"  
 12:00 - 23:59 "Shift2"

```
=SH() Printout at 10:00 Uhr: "Shift1"
=SH() Printout at 13:00 Uhr: "Shift2"
```

#### Set shift times

```
SOH F C I D - - r N N H H M M h h m m ETB
```

NN = ID [01 ... 24]  
 HH = start hour  
 MM = start minute  
 hh = end hour  
 mm = end minute

#### Get shift variable

```
SOH F C I D - - w N N p p p p p p p p p p ETB
```

#### Answer

```
SOH A N N H H M M h h m m p p p p p p p p p p ETB
```

#### Set shift text

```
SOH F C I E - - r N N T T T T T T T T T T ETB
```

NN = ID [01 ... 24]  
 T = max. 10 characters

#### Get shift variable

```
SOH F C I E - - w N N p p p p p p p p p p ETB
```

#### Answer

```
SOH A N N ; T T T T T T T T T T ; p p p p p p p p p p ETB
```

## 8.9 User Guiding

```
SOH BM [n] = U G ( c ; t ; m ; ap ; ae ; sp ) t1 t2 t... t70 ETB
```

= UG identification user guiding

c start position for the entry

t type of entry  
 0 numerical  
 1 alphanumerical

m mode of entry  
 0 do not jump over special characters  
 1 jump over special characters

ap alignment at printing  
 0 aligned to the right side

ae alignment at entry  
 0 aligned to the right side

sp prompt text for the variable, max. 24 characters  
 The entry has to be included in ".

### Example

Entry: =UG(1;0;0;0;0;"Enter article no.")<123456>  
 Display:

```
Flexicode
Enter article no.
123456
```

## 8.10 User Guiding with Mask

```
SOH|BM|[n]=UM(c;t;m;ap;ae;sp;d;ma)t1t2t...t70|ETB
```

= UM	identification user guiding with mask
c	start position for the entry
t	type of entry (is ignored with existing mask definition)
0	numerical
1	alphanumeric
m	mode of entry (is ignored with existing mask definition)
0	do not jump over special characters
1	jump over special characters
ap	alignment at printing
0	aligned to the right side
ae	alignment at entry (always left aligned with existing mask definition)
0	right aligned
1	left aligned, cursor at the beginning of the text
2	left aligned, cursor at the start position
3	right aligned, remove fill characters
4	left aligned, cursor at the beginning of the text, remove fill characters
5	left aligned, cursor at the start position, remove fill characters
sp	prompt text for the variable, max. 24 characters The entry has to be included in ".
d	deleting setpoint value
0	setpoint value remains at key entry (inserting mode)
1	with first key press the setpoint value disappears
2	setpoint value is retained (overwrite mode)
ma	definition of mask possible mask characters are
9	numbers only
#	only numbers and leading signs
?	letters only
a	alphanumeric characters (letters and numbers)
C	any characters

### Example

Entry: =UM(1;0;0;0;0;"Enter article no.";0;"999-aa")<123-xx>  
 Display:

```
Flexicode
-----
Enter article no.
123-xx
```

## 8.11 Memory Card Data

```
SOHBM[n]=MD(FN="filename";SE='x';CH=x;SC="x";SF="x";RC="x")ETB
```

= MD	identification of memory card data
FN	file name of table onto memory card with CSV data
SE	Separator sign (default = ';')
CH	column name in the first line (0 = no, 1 = yes)
SC	name and/or number of column that should be referenced
SF	field name and/or field index of field onto the layout, which contains the searched data
RC	name and/or number of column, which contains the data to be printed



### NOTICE!

If in parameter SF a field name is indicated, this must have been defined for the appropriate field by an AC attribute statement!

### Example

```
AC[1]NAME="FCODE"
BM[2]=MD(FN="a:\daten.csv";SE=';';CH=1;SC="Farbcode";SF="FCODE";
RC="IC-Nummer")
```

Field 1	Output Field 2
00001	121478242
23252	784587448

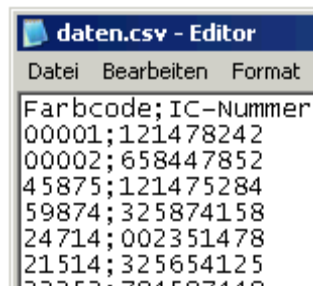

## 8.12 GS1-128 Parser



### NOTICE!

By means of this variable type, the content of an application identifier in a GS1-128 bar code can be determined.

```
SOHBM[n]=AI(p;Ai)ETB
```

= AI	identification of GS1-128 parser
p	identification of the link element (field number)
Ai	application identifier

### Example

```
Field 1 ="00123456789012345675" GS1-128 with AI00
=AI(1;"00") Printout: 123456789012345675
```

### 8.13 EPC Calculation (Electronic Product Code)\*

SOH BM [n] = E P C ( M ; L ; F ; P ; N1 ; {N2} ) ETB

= EPC identification of EPC calculation  
 M coding method  
 L length of manufacturer number (company prefix)  
 F filter value  
 P verification of check digit  
 N1 identification of link element (field number)  
 N2 identification of link element (field number) - optional

For more information, visit the following web sites:

www.epcglobalinc.org or [www.gs1.org](http://www.gs1.org)

Param.	Value range		
M	0 = coding method SSCC96	3 = coding method GRAI96	
	1 = coding method SGTIN96	4 = coding method GIAI96	
	2 = coding method SGLN96		
L	6...12		
F	<b>Coding</b>	<b>Filter value</b>	<b>Binary</b>
	SSCC96	All Others	000
Undefined		001	
Logistical / Shipping Unit		010	
SGTIN96	All Others	000	
	Retail Consumer Trade Item	001	
	Standard Trade Item Grouping	010	
	Single Shipping/ Consumer Trade Item	011	
SGLN	All Others	000	
	Physical Location	001	
GRAI	All Others	000	
	GIAI	All Others	000
P	0 = no verification; 1 = verification		
N1, N2	any		

#### Example 1

Field 1 ="00123456789012345675" GS1-128 with AI00  
 Field 2 =AI(1;"00") --> Printout: 123456789012345675  
 Field 3 =EPC(0;12;0;1;2) --> Printout: 3100DA7557D32C38E7000000

The EPC is calculated with the content of Field 2. The coding method SSCC96 is used. In Field 2 a valid NVE must be represented (18-digit, correct check digit).

#### Example 2

Field 1 ="4141234567890128254123" GS1-128 with AI00, AI254  
 Field 2 =AI(1;"414") --> Printout: 1234567890128  
 Field 3 =AI(1;"254") --> Printout: 123  
 Field 4 =EPC(2;10;0;0;2;3) --> Printout: 3208499602D218000000007B

The EPC is calculated with the content of Field 2 and Field 3. The coding method SGLN96 is used. In Field 2 a valid ILN must be represented (13-digit). In the example, Field 3 contains an optional serial number. No verification of check digit of ILN (8) is effected.

\* only when using option RFID

## 8.14 Check Digit

SOH	BM	[n]	=	C	D	(	d	;	s	;	l	;	t	;	w	;	m	;	r	;	o	)	t1	t...	t70	ETB
-----	----	-----	---	---	---	---	---	---	---	---	---	---	---	---	---	---	---	---	---	---	---	---	----	------	-----	-----

- = CD Identification of check digit
- d Data for check digit calculation (field number of constant text)  
Constant text is enclosed in "".
- s Start position within data  
1 ...n Start calculation at digit x
- l Number of digits. If the parameter is not indicated, the remaining data (from start position) is used for the check digit calculation.
- t Check digit type
- |   |                          |
|---|--------------------------|
| 0 | Modulo 10 (weighting 3)  |
| 1 | Modulo 11                |
| 2 | Modulo 43                |
| 3 | Modulo 47 (weighting 15) |
| 4 | Modulo 47 (weighting 20) |
| 5 | Modulo 103               |
| 6 | Customized               |

### Optional parameters for customized check digit

- w Weighting.  
Constant text enclosed in "" - contains the individual weighting values or an interval.  
Individual values: "x1,x2"  
Interval: "x1...x2"
- m Modulo
- r Add result to
- o Print only one digit
- |   |     |
|---|-----|
| 0 | No  |
| 1 | Yes |

### Example

Entry: =CD("123456789012";0;0;0)  
Printout: 8

Entry: =CD("1234567890";0;0;6;"1,3";10;10;1)  
Printout: 5

## 8.15 Substring

SOH	BM	[n]	=	SS	(	d	;	s	;	l	)	ETB
-----	----	-----	---	----	---	---	---	---	---	---	---	-----

- = SS Identification of substring
- d Data used for substring extraction (field number or field name or constant text.  
Constant text is enclosed in "".
- s Start position within data. If this parameter is omitted, the substring extraction starts with the 1st character of the data string.  
1 n Start at digit x
- l Number of digits. If this parameter is omitted, all characters from the start position to the end of the data string are returned.  
1 ...n At the start position x digits

### Example:

Entry: =SS("1234567890";4;3)  
Printout: 456  
Field "ARTIKELNR" has the contents "370012330295"

Entry: =SS(ARTIKELNR;1;4)  
Printout: 3700



## 9 Parameter Sets

### 9.1 Layout Parameters

#### Set layout length in 1/100 mm

```
SOH F C C L - - r N N N N N N N N - ETB
```

N: value of layout length in 1/100 mm, 7 digit ASCII number

#### Get layout length in 1/100 mm

```
SOH F C C L - - w N N N N N N N N - ETB
```

#### Answer

```
SOH A N N N N N N N N - p p p p p p p p ETB
```

#### Set layout width in 1/100 mm

```
SOH F C C O - - r N N N N N N N N ETB
```

N: indication of layout width in 1/100 mm, 7 digit ASCII number

#### Get layout width in 1/100 mm

```
SOH F C C O - - w P P P P P P P P ETB
```

#### Answer

```
SOH A N N N N N N N N - p p p p p p p p ETB
```

#### Set X offset

```
SOH F C C E - - r V N N N - - - - ETB
```

V: pre-sign of offset (+ or -)

NNN: offset value, 3 digit ASCII number in 1/10 mm

#### Get X offset

```
SOH F C C E - - w p p p p p p p p ETB
```

#### Answer

```
SOH A V N N N - - - - p p p p p p p p ETB
```

#### Set layouts per cycle

```
SOH F C A D I - r N N - - - - - ETB
```

NN: number of layouts per cycle (01 ... 25)

#### Get layouts per cycle

```
SOH F C A D I - w p p p p p p p p ETB
```

#### Answer

```
SOH A N N - - - - - p p p p p p p p ETB
```

NN: current layouts per cycle

**Set layout alignment**

SOH F C C J - - r N - - - - - - ETB

N: 0 = left  
 N: 1 = centre  
 N: 2 = right

**Get layout alignment**

SOH F C C J - - w p p p p p p p p ETB

**Answer**

SOH A N - - - - - - p p p p p p p p ETB

**Set contrast**

SOH F C A B - - r N N N - - - - - ETB

NNN: Indication of contrast in % (010 ... 200)  
 It is necessary to transmit a 3 digit ASCII number

**Get contrast**

SOH F C A B - - w p p p p p p p p ETB

**Answer**

SOH A N N N N - - - - - p p p p p p p p ETB

**Set material**

SOH F C D N C - r N N N N - - - - - ETB

NNNN: indication of material  
 Type 1: paper  
 Type 2: foil

**Get material**

SOH F C D N C - w p p p p p p p p ETB

**Answer**

SOH A N N N N N - - - - - p p p p p p p p ETB

**Set number of columns**

SOH F C C H A - r N - - - - - - - ETB

N = number of columns (1...9)

**Get number of columns**

SOH F C C H A - w p p p p p p p p ETB

**Answer**

SOH A N - - - - - - - p p p p p p p p ETB

**Set column width**

SOH F C C H B - r N N N - - - - ETB

NNN: indication of column width in 1/10 mm (0 ... 999)

**Get column width**

SOH F C C H B - w p p p p p p p p ETB

**Answer**

SOH A N N N - - - - p p p p p p p p ETB

**Set line number of layout (n digits)**

SOH F B A A - - r N ETB

N: Indication of line number in ASCII (1, 10, 100, ...)

**Get line number of layout**

SOH F B A A - - w p p p p p p p p ETB

**Answer**

SOH A N - - - - - p p p p p p p p ETB

**Set flip layout**

SOH F C D O - - r N - - - - - ETB

N: 0 = flip layout Off

N: 1 = flip layout On

**Get flip layout**

SOH F C D O - - w p p p p p p p p ETB

**Answer**

SOH A N - - - - - p p p p p p p p ETB

**Set layout rotation**

SOH F C D N - - r X - - - - - ETB

X: 0 = rotate layout Off

X: 1 = rotate layout On

**Get layout rotation**

SOH F C D N - - w p p p p p p p p ETB

x

**Answer**

SOH A X - - - - - p p p p p p p p ETB

**Set operating mode flip/rotate layout**

SOH	F	C	D	S	-	-	r	N	-	-	-	-	-	-	-	ETB
-----	---	---	---	---	---	---	---	---	---	---	---	---	---	---	---	-----

N: 0 = flip/rotate layout at the centre point of layout

N: 1 = flip/rotate layout at the centre point of printhead

**Get operating mode flip/rotate layout**

SOH	F	C	D	S	-	-	w	p	p	p	p	p	p	p	p	ETB
-----	---	---	---	---	---	---	---	---	---	---	---	---	---	---	---	-----

**Answer**

SOH	A	N	-	-	-	-	-	p	p	p	p	p	p	p	p	ETB
-----	---	---	---	---	---	---	---	---	---	---	---	---	---	---	---	-----

## 9.2 Machine Parameters

### Set operating mode

```
SOH F C A D H - r N - - - - - ETB
```

N: 1 = process single items

N: 2 = continuous

### Get operating mode

```
SOH F C A D H - w p p p p p p p p ETB
```

### Answer

```
SOH A N - - - - - p p p p p p p p ETB
```

N: current operating mode

### Set print speed

```
SOH F C A A - - r N N N - - - - - ETB
```

NNN: Indication of print speed in mm/s

It is necessary to transmit a 3 digit ASCII number.

### Get print speed

```
SOH F C A A - - w p p p p p p p p ETB
```

### Answer

```
SOH A N N N - - - - - p p p p p p p p ETB
```

### Set back speed

```
SOH F C A D G - r N N N - - - - - ETB
```

NNN: indication of back speed in mm/s (050 ... 400)

### Get back speed

```
SOH F C A D G - w p p p p p p p p ETB
```

### Answer

```
SOH A N N N - - - - - p p p p p p p p ETB
```

NNN: current back speed

### Set print offset

```
SOH F C A D L - r N N N N - - - - - ETB
```

NNNN: print offset in 1/10 mm (0000 ... 9999)

### Get print offset

```
SOH F C A D L - w p p p p p p p p ETB
```

### Answer

```
SOH A N N N N - - - - - p p p p p p p p ETB
```

NNNN: current print offset

### 9.3 Device Settings

#### Set print position

```
SOH F C A D K - r N N N N N N - - ETB
```

NNNNN: print position in 1/10 mm (0000 ... 0043)

#### Get print position

```
SOH F C A D K - w p p p p p p p p ETB
```

#### Answer

```
SOH A N N N N N N - - p p p p p p p p ETB
```

NNNNN: print position in 1/10 mm

#### Set operating mode

```
SOH F C A D O - r N - - - - - - ETB
```

N: 0 = intermittent mode

N: 1 = continuous mode

After changing the operating mode, the module is re-started automatically.

#### Get operating mode

```
SOH F C A D O - w p p p p p p p p ETB
```

#### Answer

```
SOH A N - - - - - - p p p p p p p p ETB
```

#### Set transfer ribbon control On/Off

```
SOH F C D B - - r N M - - - - - ETB
```

N: 1 = transfer ribbon control Off

N: 0 = transfer ribbon control On

#### Get transfer ribbon control On/Off

```
SOH F C D B - - w p p p p p p p p ETB
```

#### Answer

```
SOH A N M - - - - - p p p p p p p p ETB
```

**Set field handling**

SOH F C D K - - r N - - - - - - ETB

N: 0 = field handling Off

N: 1 = graphic received

N: 2 = delete graphic

N: 3 = Restor graphic

**Get field handling**

SOH F C D K - - w p p p p p p p ETB

**Answer**

SOH A N - - - - - - p p p p p p p p ETB

**Set display language**

SOH F C D I - - r N - - - - - - ETB

N: 0 = German

N: 8 = Italian

N: 15 = not used

N: 1 = English

N: 9 = Danish

N: 16 = Ukrainian

N: 2 = French

N: 10 = Polish

N: 17 = Turkish

N: 3 = Spanish

N: 11 = Greek

N: 18 = Swedish

N: 4 = Finish

N: 12 = Hungarian

N: 19 = Norwegian

N: 5 = Czech

N: 13 = Russian

N: 20 = Estonian

N: 6 = Portuguese

N: 14 = Chinese

N: 21 = Romanian

N: 7 = Netherlands

**Get display language**

SOH F C D I - - w p p p p p p p ETB

**Answer**

SOH A N - - - - - - p p p p p p p p ETB

**Set external print parameters**

SOH F C C P - - r N - - - - - - ETB

N: 0 = only parameter settings by interface for label length, gap length and label width are taken into consideration.

N: 1 = parameter settings by interface are processed

N: 2 = parameter settings by interface are not taken into consideration

**Get external print parameters**

SOH F C C P - - w p p p p p p p ETB

**Answer**

SOH A N - - - - - - p p p p p p p p ETB

**Set Codepage**

SOH F C C N - - r N - - - - - - ETB

- N: 0 = ANSI  
 N: 1 = Codepage 437 (english)  
 N: 2 = Codepage 850  
 N: 3 = GEM German  
 N: 4 = GEM English  
 N: 5 = GEM French  
 N: 6 = GEM Swedish  
 N: 7 = GEM Danish  
 N: 8 = Codepage 437 (Greek)  
 N: 9 = Codepage 852 (Eastern European)  
 N: 0 = Codepage 857 (Turkish)

**Get Codepage**

SOH F C C N - - w p p p p p p p p ETB

**Answer**

SOH A N - - - - - - p p p p p p p p ETB

**Set user guiding**

SOH F C D U - - r N - - - - - - ETB

- N: 0 = Off, no entries are possible but pre-set values are printed.  
 N: 1 = On, the user has to enter a value for each variable or to confirm the pre-set values by pressing the enter key. This default value is set each time the print module is switched on  
 N: 2 = Auto, the entries for a layout are repeated after each print and the last entered values are the new pre-set values.

**Get user guiding**

SOH F C D U - - w p p p p p p p p ETB

**Answer**

SOH A N - - - - - - p p p p p p p p ETB

**Set keyboard layout**

SOH F C C K - - r N - - - - - - ETB

- |                |                    |
|----------------|--------------------|
| N: 0 = German  | N: 4 = Spanish     |
| N: 1 = English | N: 5 = Swedish     |
| N: 2 = French  | N: 6 = US American |
| N: 3 = Greek   | N: 7 = Russian     |

**Get keyboard layout**

SOH F C C K - - w p p p p p p p p ETB

**Answer**

SOH A N - - - - - - p p p p p p p p ETB

**Set sound level of key click (buzzer)**

SOH F C C B - - w p p p p p p p p ETB

N: 0 = buzzer Off

N: 1-7 = sound level of key click

**Get sound level of key click (buzzer)**

SOH F C C B - - w p p p p p p p p ETB

**Answer**

SOH A N - - - - - p p p p p p p p ETB

**Set brightness of display (contrast)**

SOH F C C B B - r N N N - - - - - ETB

NNN = value range of display brightness 045 ... 075

**Get display brightness**

SOH F C C B B - w p p p p p p p p ETB

**Answer**

SOH A N N N - - - - - p p p p p p p p ETB

**Set hotstart On/Off**

SOH F C D W - - r N - - - - - - - ETB

N: 0 = Off

N: 1 = On

**Get hotstart On/Off**

SOH F C D W - - w p p p p p p p p ETB

**Answer**

SOH A N - - - - - - - p p p p p p p p ETB

**Set autoload**

SOH F C D X - - r N - - - - - - - ETB

N: 0 = Off

N: 1 = On

**Get autoload**

SOH F C D X - - w p p p p p p p p ETB

**Answer**

SOH A N - - - - - - - p p p p p p p p ETB

**Set default layout On/Off**

SOH F C M K E - r N - - - - - ETB

N: 0 = Off: Print start without layout definition signalises error.

N: 1 = On: Default layout is printed without layout definition.

Default: Off

**Get default layout On/Off**

SOH F C M K E - w p p p p p p p p ETB

**Answer**

SOH A N - - - - - p p p p p p p p ETB

**Set layout change confirmation**

SOH F C S D F C r N - - - - - ETB

N: 0 = Confirmation Off

N: 1 = Confirmation On

**Get layout change confirmation**

SOH F C S D F C w p p p p p p p p ETB

**Answer**

SOH A N - - - - - p p p p p p p p ETB

**Set 'print after measuring'**

SOH F C S D F D r N - - - - - ETB

N: 0 = Off

N: 1 = On

**Get 'print after measuring'**

SOH F C S D F D w p p p p p p p p ETB

**Answer**

SOH A N - - - - - p p p p p p p p ETB

## 9.4 Ribbon Save

### Set ribbon save mode

```
SOH F C D R A - r N - - - - - ETB
```

N = 0: Aus

N = 1: Standard

### Get ribbon save mode

```
SOH F C D R A - w p p p p p p p p ETB
```

### Answer

```
SOH A N - - - - - p p p p p p p p ETB
```

### Set synchronisation of transfer ribbon and printhead

```
SOH F C D R B - r N N N - - - - - ETB
```

NNN: Value of synchronization in % (000 ... 100)

### Get synchronization of transfer ribbon and printhead

```
SOH F C D R B - w p p p p p p p p ETB
```

### Answer

```
SOH A N N N - - - - - p p p p p p p p ETB
```

### Set time for printhead move down

```
SOH F C D R C A r N N N N - - - - - ETB
```

NNNN: value of time for printhead move down in ms (0000 ... 9999)

### Get time for printhead move down

```
SOH F C D R C A w p p p p p p p p ETB
```

### Answer

```
SOH A N N N N - - - - - p p p p p p p p ETB
```

### Set feedback distance

```
SOH F C D R F A r N N N N - - - - - ETB
```

NNNN: distance in mm

### Get feedback distance

```
SOH F C D R F A w p p p p p p p p ETB
```

### Answer

```
SOH A N N N N - - - - - p p p p p p p p ETB
```

**Set feedback speed**

SOH F C D R F B r N N N N - - - - ETB

NNNN: feedback speed in mm/s

**Get feedback speed**

SOH F C D R F B w p p p p p p p p ETB

**Answer**

SOH A N N N N - - - - p p p p p p p p ETB

**Set power of transfer ribbon motor**

SOH F C D R D A r N N N - - - - - ETB

NNN: value of transfer ribbon motor power in % (010 ... 200)

**Get power of transfer ribbon motor**

SOH F C D R D A w p p p p p p p p ETB

**Answer**

SOH A N N N - - - - - p p p p p p p p ETB

**Set brake power for acceleration and braking**

SOH F C D R E A r N N N - - - - - ETB

NNN: value of brake power for acceleration and braking  
in % (000 ... 200)**Get brake power for acceleration and braking**

SOH F C D R E A w p p p p p p p p ETB

**Answer**

SOH A N N N - - - - - p p p p p p p p ETB

**Set brake power during printing**

SOH F C D R E B r N N N - - - - - ETB

NNN: value of brake power during printing in % (000 ... 200)

**Get brake power during printing**

SOH F C D R E B w p p p p p p p p ETB

**Answer**

SOH A N N N - - - - - p p p p p p p p ETB

## 9.5 Interface

By means of the following commands the parameters of the serial interface can be set. Note that after sending one of the commands also the host computer changes the corresponding parameter of its interface to allow further communication of host computer-printing system.

For all interface commands the interface is fixed with x. The following values are allowed:

x = 1 ⇒ COM 1

x = 2 ⇒ COM 2

In all other cases automatically the first serial interface is addressed. In the answers the addressed interface is also returned.

### Set all interface parameters

```
[SOH] F C F F x - r m ; b ; p ; d ; s [ETB]
```

m = mode (0 = Off, 1 = On, 2 = On, without error message)

b = baud rate (2400, 4800, 9600, 19200, 38400, 115200)

p = parity (n = no parity, e = even parity, o = odd parity)

d = number of data bits (7, 8)

s = number of stop bits (1, 2)

### Get all interface parameters

```
[SOH] F C F F x - w p p p p p p p p [ETB]
```

### Answer

```
[SOH] A x ; m ; b ; p ; d ; s ; p p p p p p p p [ETB]
```

**Example:** activate interface COM1 and set 9600 Baud, no parity, 8 data bits, 2 stop bits  
[SOH]FCFF1-r1;9600;n;8;2[ETB]

## Interface protocol

There are two different interface protocols available. Usually SOH = 01<sub>Hex</sub> and ETB = 17<sub>Hex</sub>. However there are host computers (e.g. AS/400), which cannot work with these characters. Therefore you can switch SOH = 5E<sub>Hex</sub> and ETB = 5F<sub>Hex</sub>. The host computer has to change the corresponding parameter as well.

### Set SOH and ETB

```
[SOH] F C G C - - r N - - - - - [ETB]
```

N: 0 = SOH = 01<sub>Hex</sub>, ETB = 17<sub>Hex</sub>

N: 1 = SOH = 5E<sub>Hex</sub>, ETB = 5F<sub>Hex</sub>

### Get SOH and ETB

```
[SOH] F C G C - - W p p p p p p p p [ETB]
```

### Answer

```
[SOH] A N - - - - - p p p p p p p p [ETB]
```

N: 0 = SOH = 01<sub>Hex</sub>, ETB = 17<sub>Hex</sub>

N: 1 = SOH = 5E<sub>Hex</sub>, ETB = 5F<sub>Hex</sub>

N: 2 = other character combination

**Data memory****Set data memory**

SOH F C G D - - r M - - - - - ETB

M: 0 = Off, after receiving FBCA0r or FBDA0r the interface is locked until the end of the print order, i.e. you cannot write more data in the receiving buffer.

M: 1 = Standard: After a print order is started, no data from the receive buffer is processed; however, additional data can be written to the receive buffer until it is full.

M: 2 = Extended, after starting a print order it is possible to write more data in the receiving buffer. These data is processed during the print and the next layout is prepared.

**Get data memory**

SOH F C G D - - W p p p p p p p p ETB

**Answer**

SOH A M - - - - - p p p p p p p p ETB

**Set reaction to unknown interrogative set**

SOH F C G E A - r N - - - - - ETB

N = value range between 0 and 3

**Get reaction to unknown questions**

SOH F C G E A - w p p p p p p P p ETB

**Answer**

SOH A N - - - - - p p p p p p p p ETB

## 9.6 Network

```
SOH F C L A - - r C 0 A 8 0 0 1 5 ETB
```

All network parameter sets start in the third column with a 'L'. Column 4 shows the identification for the corresponding network parameter. Column 5 can show another sub-identification.

Because of the fact that the argument size is limited to 8 characters, the IP addresses (IP address, network mask, gateway address) which consist of 32 bit are transmitted in HEX presentation.

For all data which is transmitted in HEX presentation (also the MAC address) it is allowed to use capital as well as small letters.

In contrary to the parameter settings of the other interfaces, the settings of the following sets were saved immediately onto Flash, i.e. it is not necessary to save the currently set configuration before switching off the printing system so the modifications are still available after switching on.

So that the made modifications become active, also without printing system Reset it is necessary to transmit a corresponding Z set which effects a Reset of the network devices.

### Set IP address (e.g. 192.168.0.21)

```
SOH F C L A - - r C 0 A 8 0 0 1 5 ETB
```

### Get IP address

```
SOH F C L A - - w p p p p p p p ETB
```

### Answer

```
SOH A C 0 A 8 0 0 1 5 p p p p p p p ETB
```

### Set netmask (e.g. 255.255.255.0)

```
SOH F C L B - - r F F F F F F 0 0 ETB
```

### Get netmask

```
SOH F C L B - - w F F F F F F 0 0 ETB
```

### Answer

```
SOH A F F F F F F 0 0 p p p p p p p ETB
```

### Set Gateway address (e.g. 192.168.0.1)

```
SOH F C L C - - r C 0 A 8 0 0 0 1 ETB
```

### Get Gateway address

```
SOH F C L C - - w p p p p p p p ETB
```

### Answer

```
SOH A C 0 A 8 0 0 0 1 p p p p p p p ETB
```



With the A record any address can be set in our pool.

With the C record any address in our pool and the identification of the MAC address can be set/changed at the same time.

#### Get MAC address

```
SOH F C L M B - w p p p p p p p p ETB
```

```
SOH F C L M A - w p p p p p p p p ETB
```

```
SOH F C L M C - w p p p p p p p p ETB
```

#### Answer

```
SOH A 0 0 0 7 4 A - - p p p p p p p p ETB
```

```
SOH A 4 3 1 9 0 8 - - p p p p p p p p ETB
```

```
SOH A 0 0 0 7 4 A 4 3 1 9 0 8 p p p p p p p p ETB
```

#### NTP Server

NTP (Network Time Protocol) is a standardized Internet protocol permitting the synchronization of real-time clocks of network participants. The direct print module connects itself with a time server and align every 60 minutes its internal real-time clock with that of the time server in order to correct possible differences.

The address of server (IP address) can be freely configured in the printing system. The communication is effected by UDP and the fixed set port 123. The service in the direct print module is deactivated by transmitting the server address 0.0.0.0.

The time servers work together with the coordinated world time (UTC) and therefore an additional time shift is needed compared to the reference time. For Germany it is e.g. +1 hour.

The current state of the connexion can be queried with a status set.

#### Set NTP Server IP

```
SOH F C L N I - r N ETB
```

N: X.X.X.X (X = 0 ... 255)

#### Get NTP Server IP

```
SOH F C L N I - w p p p p p p p p ETB
```

#### Answer

```
SOH A N N N N N N N N N p p p p p p p p ETB
```

0.0.0.0 deactivates the NTP service

**Readout NTP status**

SOH F C L N S - w p p p p p p p p p ETB

**Answer**

SOH A N - - - - - p p p p p p p p p ETB

N: 0 = Off

N: 1 = OK

N: 2 = Error

**Set time zone (hour offset)**

SOH F C L N Z - r N ETB

N: -12, 12

**Get time zone (hour offset)**

SOH F C L N Z - w p p p p p p p p p ETB

**Answer**

SOH A N N N N N N N N N p p p p p p p p p ETB

**Reset Network Device**

SOH F C L Z - - r ----- ETB

For this set is no enquiry possible. This set causes that modifications made by the transfer of the previous sets become effective.

## 9.7 Sensors

### Get condition of compressed air

```
SOH F C M B H - w p p p p p p p p ETB
```

#### Answer

```
SOH A N - - - - - p p p p p p p p ETB
```

N: 0 = no or not enough compressed air

N: 1 = compressed air OK

### Get condition of cover

```
SOH F C M B I - w p p p p p p p p ETB
```

#### Answer

```
SOH A N - - - - - p p p p p p p p ETB
```

N: 0 = cover open

N: 1 = cover closed

## 9.8 Offset Values

### Set X offset

```
SOH F C C E - - r V N N N - - - - ETB
```

V: offset prefix (+ or -)

NNN: offset value, 3 digit ASCII number in 1/10 mm

### Get X offset

```
SOH F C C E - - w p p p p p p p p ETB
```

#### Answer

```
SOH A V N N N - - - - p p p p p p p p ETB
```

### Set print offset

```
SOH F C A D L A r N N N N N - - M ETB
```

NNNNN: value of print offset

M: Unit - 0 = print offset in 1/10 mm (00000 ... 09999)

1 = print offset in 1/10 ms (00000 ... 99999)

### Get print offset

```
SOH F C A D L A w p p p p p p p p ETB
```

#### Answer

```
SOH A N N N N N - - M p p p p p p p p ETB
```

NNNNN: value of print offset

M: Unit - 0 = print offset in 1/10 mm

1 = print offset in 1/10 ms

## 9.9 Service Functions

### Set Online / Offline

```
SOH F C M K C - r M - - - - - ETB
```

M: 0 = Offline Off

M: 1 = Offline On

### Get Online / Offline

```
SOH F C M K C - w p p p p p p p p ETB
```

### Answer

```
SOH A M - - - - - p p p p p p p p ETB
```

After changing by interface the display is automatically new initialized (by activated online/offline changing to online indication).

### Set reprint action

```
SOH F C M K D - r N - - - - - ETB
```

### Get reprint action

```
SOH F C M K D - w p p p p p p p p ETB
```

N: 0 = complete reprint

N: 1 = empty reprint

### Answer

```
SOH A N - - - - - p p p p p p p p ETB
```

### Get position of printhead (close printhead)

```
SOH F C M B C - r N - - - - - ETB
```

N: 1 = printhead down (closed)

### Get condition of printhead photocell

```
SOH F C M B C - w p p p p p p p p ETB
```

### Answer

```
SOH A N - - - - - p p p p p p p p ETB
```

N: 0 = printhead is open

N: 1 = printhead is closed

### Get position of printhead (open printhead)

```
SOH F C M B D - r N - - - - - ETB
```

N: 1 = printhead up (open)

### Get condition of printhead photocell

```
SOH F C M B C - w p p p p p p p p ETB
```

### Answer

```
SOH A N - - - - - p p p p p p p p ETB
```

N: 0 = printhead is open

N: 1 = printhead is closed

**Get printhead temperature**

SOH F C M C - - w p p p p p p p p p ETB

**Answer**

SOH A N - - - - - p p p p p p p p ETB

NNN: value of temperature, 3 digit ASCII number in degrees

**Set transfer ribbon length**

SOH F C D Q A - r N N N N - - - - ETB

NNNN: value of transfer ribbon length in m

Possible entries: 300, 450, 600, 900 or 1000

**Get transfer ribbon length**

SOH F C D Q A - w p p p p p p p p ETB

**Answer**

SOH A N - - - - - p p p p p p p p ETB

**Set transfer ribbon prior warning**

SOH F C M L A - r N - - - - - - ETB

N: 0 = Off

N: 1 = On

**Get transfer ribbon prior warning**

SOH F C M L A - w p p p p p p p p ETB

**Answer**

SOH A N - - - - - p p p P p p p p ETB

**Set diameter for transfer ribbon prior warning**

SOH F C M L B - r N N N - - - - - ETB

NNN: 030 ... 090 diameter in mm

**Get transfer ribbon prior warning**

SOH F C M L B - w p p p p p p p p ETB

**Answer**

SOH A N - - - - - p p p p p p p p ETB

**Get current transfer ribbon diameter**

SOH F C M L C - w - - - - - - - - ETB

**Answer**

SOH A N N N - - - - - p p p p p p p p ETB

**Set mode for transfer ribbon prior warning**

SOH F C M L D A r N - - - - - - - - ETB

N: 0 = Warning

N: 2 = Error

**Get mode for transfer ribbon prior warning**

SOH F C M L D A w p p p p p p p p ETB

**Answer**

SOH A N - - - - - - - - p p p p p p p p ETB

**Set printhead resistance**

SOH F C M G - - r N N N N N - - - - - ETB

NNNNN: value of resistance in Ohm.

**Get printhead resistance**

SOH F C M G - - w p p p p p p p p p ETB

**Answer**

SOH A N N N N N N - - - - - p p p p p p p p ETB

**Set custom logo**

SOH F C N R A - r N - - - - - - - - ETB

N: 0 = Off

N: 1 = On

**Get custom logo**

SOH F C N R A - w p p p p p p p p p ETB

**Answer**

SOH A N - - - - - - - - p p p p p p p p ETB

**Paper counter**

The paper counter (kilometer value) of direct print module as well as of printhead can only be enquired by interface and not reset to 0.

**Get paper counter of direct print module**

```
SOH F C H A - - w p p p p p p p p ETB
```

**Answer**

```
SOH A N N N N N N N N N p p p p p p p p ETB
```

**Get paper counter of printhead**

```
SOH F C H B - - w p p p p p p p p ETB
```

**Answer**

```
SOH A N N N N N N N N N p p p p p p p p ETB
```

NNNNNNNN: kilometer value of printing system and/or printhead in meters (e.g. '00000123' = 123 m)

**9.10 Date & Time****Set date**

```
SOH F C I A - - r D D M O Y Y D W ETB
```

DD = day of month

MO = month

YY = year

DW = day of week ('00' = Sunday)

**Get date**

```
SOH F C I A - - w p p p p p p p p ETB
```

**Answer**

```
SOH A D D M O Y Y D W p p p p p p p p ETB
```

**Set time**

```
SOH F C I B - - r H H M I S S A M ETB
```

HH = hours

MI = minutes

SS = seconds

AM = mode ('am' = 12 hours mode AM, 'pm' = 12 hours mode PM,

'—' = 24 hours mode)

**Get time**

```
SOH F C I B - - w p p p p p p p p ETB
```

**Answer**

```
SOH A H H M I S S A M p p p p p p p p ETB
```

### Automatically adjust clock for daylight saving changes

Because of the fact that there is no world-wide regulation if and when a changing of time between summer and wintertime (normal time) in the individual countries takes place, we distinguish between the following four formats for the definition for beginning and end of summertime.

<b>F 0:</b>	European format start of summertime = last Sunday in March end of summertime = last Sunday in October <b>W:</b> week (1 = first, ..., 5 = last) <b>WD:</b> day of week (0 = Sunday, ..., 6 = Saturday) <b>MM:</b> month (01 = January, ..., 12 = December)
<b>F 1:</b>	Fix date with indication of year <b>DD:</b> day <b>MM:</b> month (01 = January, ..., 12 = December) <b>YY:</b> year
<b>F 2:</b>	Fix date without indication of year <b>DD:</b> day <b>MM:</b> month (01 = January, ..., 12 = December)
<b>F 3:</b>	Week day after day in month <b>WD:</b> day of week (0 = Sunday, ..., 6 = Saturday) <b>DD:</b> after day (only the first day is taken into consideration) <b>MM:</b> month (01 = January, ..., 12 = December)

### Set automatically adjust clock for daylight saving changes

SOH F C I G - - r N - - - - - ETB

### Get automatically adjust clock for daylight saving changes

SOH F C I G - - w p p p p p p p p ETB

### Answer

SOH A N - - - - - p p p p p p p p ETB

N: 0 = Automatically adjust clock for daylight saving changes Off  
N: 1 = Automatically adjust clock for daylight saving changes On

**Set beginning of summertime**

F 0: SOH F C I H - - r F W ; W D ; M M ; H H ; M M ETB

F 1: SOH F C I H - - r F D D ; M M ; Y Y ; H H ; M M ETB

F 2: SOH F C I H - - r F D D ; M M ; H H ; M M ETB

F 3: SOH F C I H - - r F W D ; D D ; M M ; H H ; M M ETB

**Get beginning of summertime**

SOH F C I H - - w p p p p p p p p ETB

**Answer**

SOH A F W W D M M p p p p p p p p ETB

The answer depends on each set format.

**Set end of summertime**

F 0: SOH F C I I - - r F W ; W D ; M M ; H H ; M M ETB

F 1: SOH F C I I - - r F D D ; M M ; Y Y ; H H ; M M ETB

F 2: SOH F C I I - - r F D D ; M M ; H H ; M M ETB

F 3: SOH F C I I - - r F W D ; D D ; M M ; H H ; M M ETB

**Get end of summertime**

SOH F C I I - - w p p p p p p p p ETB

**Answer**

SOH A F W W D M M p p p p p p p p ETB

The answer depends on each set format.

**Set time shifting**

SOH F C I J - - r N N N - - - - ETB

NNN: minutes

**Get time shifting**

SOH F C I J - - w p p p p p p p p ETB

**Answer**

SOH A N N N p p p p p p p p ETB

## 9.11 Password

### Set password

SOH	F	C	K	A	-	-	r	N	N	N	N	-	-	-	-	ETB
-----	---	---	---	---	---	---	---	---	---	---	---	---	---	---	---	-----

NNNN = input of password  
4 digit ASCII number in mm (0000 ... 9999)

### Get password

SOH	F	C	K	A	-	-	w	p	p	p	p	p	p	p	p	p	ETB
-----	---	---	---	---	---	---	---	---	---	---	---	---	---	---	---	---	-----

### Answer

SOH	A	N	N	N	N	-	-	-	-	p	p	p	p	p	p	p	ETB
-----	---	---	---	---	---	---	---	---	---	---	---	---	---	---	---	---	-----

### Set function group

SOH	F	C	K	B	-	-	r	A	B	C	D	E	-	-	-	ETB
-----	---	---	---	---	---	---	---	---	---	---	---	---	---	---	---	-----

A: Function menu  
0 = password Off  
1 = password On

B: CF card  
0 = password Off  
1 = standard directory allowed  
2 = password On

C: not assigned

D: Printer guiding  
0 = password Off  
1 = not assigned  
2 = Password On

E: Favorites menu  
0 = password Off  
1 = password On

### Get function group

SOH	F	C	K	B	-	-	w	p	p	p	p	p	p	p	p	ETB
-----	---	---	---	---	---	---	---	---	---	---	---	---	---	---	---	-----

### Answer

SOH	A	a	b	c	d	e	-	-	-	p	p	p	p	p	p	p	ETB
-----	---	---	---	---	---	---	---	---	---	---	---	---	---	---	---	---	-----

**Set password function menu**

SOH F C K D A - r N N N N - - - - ETB

NNNN = input of password  
4 digit ASCII number in mm (0000 ... 9999)

**Get password function menu**

SOH F C K D A - w p p p p p p p p ETB

**Answer**

SOH A N N N N - - - - p p p p p p p p ETB

**Set password favorites menu**

SOH F C K D B - r N N N N - - - - ETB

NNNN = input of password  
4 digit ASCII number in mm (0000 ... 9999)

**Enquire password favorites menu**

SOH F C K D B - w p p p p p p p p ETB

**Answer**

SOH A N N N N - - - - p p p p p p p p ETB

**Set password memory card**

SOH F C K D C - r N N N N - - - - ETB

NNNN = input of password  
4 digit ASCII number in mm (0000 ... 9999)

**Get password memory card**

SOH F C K D C - w p p p p p p p p ETB

**Answer**

SOH A N N N N - - - - p p p p p p p p ETB

**Set password printing manually**

SOH F C K D D - r N N N N - - - - ETB

NNNN = input of password  
4 digit ASCII number in mm (0000 ... 9999)

**Get printing manually**

SOH F C K D D - w p p p p p p p p ETB

**Answer**

SOH A N N N N - - - - p p p p p p p p ETB

## 9.12 Compact Flash Card

### Save a layout onto Compact Flash card

SOH F M A O - - r P ETB

- O: In case a layout with the entered name exists already then the layout is overwritten without an enquiry. If you enter another value as 0, an enquiry appears demanding if you want to overwrite.
- P: File name of the layout which is to save. Drive and path name are optional, i.e. the file name is allowed to have more than 8 characters but is limited to 79.

### Load a file from Compact Flash card

SOH F M B - - - r P ETB

- P: File name of the layout which is to load. Drive and path name are optional, i.e. the file name is allowed to have more than 8 characters but is limited to 79.

### Delete a layout from Compact Flash card

SOH F M C - - - r P ETB

- P: File name of the layout which is to delete. Drive and path name are optional, i.e. the file name is allowed to have more than 8 characters but is limited to 79.

### Format Compact Flash card

SOH F M D - - - r P ETB

- P: Optional drive identification with colon (e.g. A:).  
In case no drive is indicated, then the currently selected is formatted.

### Readout contents of CF card

SOH F M G O - - r P ETB

- O: In case O is indicated, no error messages are displayed at the printing display e.g. if no card is inserted.
- P: Optional drive identification with colon (e.g. A:).  
In case no drive is indicated, then the currently selected is read out.

### Answer

SOH File name/directory name ETB

A list of all file entries is indicated, each entry is included in (SOH) and (ETB).

**Readout free memory space**

SOH	F	M	H	O	-	-	w	X	p	p	p	p	p	p	p	p	ETB
-----	---	---	---	---	---	---	---	---	---	---	---	---	---	---	---	---	-----

O: In case O is indicated, no error messages are displayed at the printing display e.g. if no card is inserted.

X = Drive [A,B] (optional)

**Answer**

SOH	A	X	n	n	n	n	-	-	-	p	p	p	p	p	p	p	ETB
-----	---	---	---	---	---	---	---	---	---	---	---	---	---	---	---	---	-----

X = Drive [A,B]

n = Memory space in KB

**Create directory**

SOH	F	M	I	O	-	-	r	P	ETB
-----	---	---	---	---	---	---	---	---	-----

O: In case a layout with the entered name already exists, then it is overwritten without an enquiry.

If you enter another value as O, an enquiry appears demanding if you want to overwrite.

P = Drive and path indication

**Delete directory**

SOH	F	M	J	-	-	-	r	P	ETB
-----	---	---	---	---	---	---	---	---	-----

P = Drive and path indication

**NOTICE!**

The current directory cannot be deleted.

**Delete directory path**

SOH	F	M	J	A	-	-	-	r	P	ETB
-----	---	---	---	---	---	---	---	---	---	-----

Deletes the indicated directory including all containing sub-directories and files.

**Change standard directory**

SOH	F	M	K	-	-	-	r	P	ETB
-----	---	---	---	---	---	---	---	---	-----

P = Drive and path indication

**Readout current directory**

SOH	F	M	K	-	-	-	w	ETB
-----	---	---	---	---	---	---	---	-----

**Answer**

SOH	A	P	ETB
-----	---	---	-----

P = Current directory

**Set standard directory for file selection via I/O**

SOH F M K B - - r N ETB

N = directory path

**Get standard directory for file selection via I/O**

SOH F M K B - - w p p p p p p p p ETB

**Antwort**

SOH A N - - - - - p p p p p p p p ETB

**Transfer file from printing system**

SOH F M L - - - w P ETB

P: File name of file which is to transfer. Drive name and path name are optional, i.e. the file name is allowed to have more than 8 characters but is limited to 79.

**Answer**

SOH A F \* S ETB Data

F = File name  
S = File size in Byte  
Data = Binary data

**Enquiry if the file exists**

SOH F M M - - - w P ETB

P: File name of file which is to transfer. Drive name and path name are optional, i.e. the file name is allowed to have more than 8 characters but is limited to 79.

**Answer**

SOH A X P ETB Daten

X: 0 = File does not exist  
1 = File exists  
P = File name

**Readout size of Compact Flash card**

SOH F M P O - - w X ETB

O: In case O is indicated, no error messages are displayed at the printing display e.g. if no card is inserted.  
X: Drive [A,B] (optional)

**Answer**

SOH A D n n n n - - - X ETB

X = Drive [A,B]  
n = Memory in KB  
D = enquired drive

**Get drive status**

SOH	F	M	S	-	-	-	w	X	ETB
-----	---	---	---	---	---	---	---	---	-----

X - Drive [A,B]

**Answer**

SOH	A	X	S	ETB
-----	---	---	---	-----

X = Drive [A,B]

S = Status

0: no storage medium

1: not formatted

2: ready

3: not determinable

## 9.13 Printing

### Set number of lines (n digits)

```
SOH F B A A - - r N ETB
```

N = number of lines in ASCII (1, 10, 100, ...)

### Get number of lines

```
SOH F B A A - - w p p p p p p p p ETB
```

### Answer

```
SOH A N - - - - - p p p p p p p p ETB
```

### Start/Stop Command

In addition to the actual start/stop command, the print order can also be interrupted via the parameter/remote record.

```
SOH F D - - - - r N - - - - - ETB
```

N: 0 = stop printing

N: 1 = continue printing

N: 2 = cancel print order if it is already stopped

### Reset error

#### Reset error

```
SOH F C M H - - r N N N N - - - - ETB
```

NNNN: current error ID or '9999'

#### Get error

```
SOH F C M H - - w p p p p p p p p ETB
```

### Answer

```
SOH A N N N N 0 0 0 0 p p p p p p p p ETB
```

#### Get error ID and error text

```
SOH F C M H A - w p p p p p p p p ETB
```

### Answer

```
SOH A N N N N ; error text ; p p p p p p p p ETB
```

**Item number of print order**

By means of this command the Host computer can enquire following item numbers:

**Total number of current print order**

SOH	F	B	B	A	-	-	w	p	p	p	p	p	p	p	p	ETB
-----	---	---	---	---	---	---	---	---	---	---	---	---	---	---	---	-----

**Number of layouts which are still to print**

SOH	F	B	B	B	-	-	w	p	p	p	p	p	p	p	p	ETB
-----	---	---	---	---	---	---	---	---	---	---	---	---	---	---	---	-----

**Number of already printed layouts**

SOH	F	B	B	C	-	-	w	p	p	p	p	p	p	p	p	ETB
-----	---	---	---	---	---	---	---	---	---	---	---	---	---	---	---	-----

At the end of one of these commands the printing system returns the corresponding number as ASCII value (4 res. 5 digits) in the answer set.

**Answer**

SOH	A	N	N	N	N	-	-	-	-	p	p	p	p	p	p	p	ETB
-----	---	---	---	---	---	---	---	---	---	---	---	---	---	---	---	---	-----

With this set it is also possible to transmit the item number of print order to the printing system.

**Item number of print order**

SOH	F	B	B	A	-	-	r	N	N	N	N	N	-	-	-	ETB
-----	---	---	---	---	---	---	---	---	---	---	---	---	---	---	---	-----

NNNNN = 5 digits item number of order

**Interval in cutter mode**

SOH	F	B	B	D	-	-	r	N	N	N	N	-	-	-	-	ETB
-----	---	---	---	---	---	---	---	---	---	---	---	---	---	---	---	-----

NNNNN: interval

**Start printing**

SOH	F	B	C	-	-	-	r	S	-	-	-	-	-	-	ETB
-----	---	---	---	---	---	---	---	---	---	---	---	---	---	---	-----

This command starts the print order which is actually set in the printing system. The current parameters such as print mode, speed, initialization etc. are used.

S = x: sorted (e.g. pages 1-5, then again 1-5 etc. are printed)

S = 1: unsorted (page 1 is printed x times, then page 2 x times, etc.)

SOH	F	B	E	-	-	-	r	n	n	n	n	n	n	n	n	n	ETB
-----	---	---	---	---	---	---	---	---	---	---	---	---	---	---	---	---	-----

With this command the printjob identifier which appears in "printing" res. "stopped" window is assigned to a print order. If only blanks are transmitted, then the printjob identifier is deleted and the display shows "noname".

**Initialization of page handling**

SOH	F	B	F	-	-	-	r	ETB
-----	---	---	---	---	---	---	---	-----

**Selection of current page**

SOH	F	B	G	-	-	-	r	P	ETB
-----	---	---	---	---	---	---	---	---	-----

P = current page number [1 ... 9]

**Select order of pages to be printed**

SOH	F	B	H	-	-	-	r	P <sub>1</sub>	P <sub>2</sub>	P <sub>3</sub>	ETB
-----	---	---	---	---	---	---	---	----------------	----------------	----------------	-----

P<sub>1</sub>; P<sub>2</sub>;... = pages to be printed

**Generation of page without print start**

SOH	F	B	I	-	-	-	r	S	ETB
-----	---	---	---	---	---	---	---	---	-----

With this command the corresponding page is only generated, i.e. no print start signal is sent.

S = x: sorted (e.g. pages 1-5, then again 1-5 etc. are printed)

S = 1: unsorted (page 1 is printed x times, then page 2 x times, etc.)

## Feed

### Parameter set to release a feed

SOH	F	E	-	-	-	-	r	-	-	-	-	-	-	-	-	-	ETB
-----	---	---	---	---	---	---	---	---	---	---	---	---	---	---	---	---	-----

## Ribon feed

### Parameter set to release a ribbon feed

SOH	F	E	B	-	-	-	r	d	;	v	-	-	-	-	ETB
-----	---	---	---	---	---	---	---	---	---	---	---	---	---	---	-----

Direct Coder: Ribbon feed with indication of distance and speed

d: Distance in mm

v: Speed in mm/s

## Test print

### Parameter set to release a test print

SOH	F	F	-	-	-	-	r	-	-	-	-	-	-	-	-	ETB
-----	---	---	---	---	---	---	---	---	---	---	---	---	---	---	---	-----

## Status print

### Parameter set to print a status print

SOH	F	C	M	Q	-	-	r	N	-	-	-	-	-	-	-	ETB
-----	---	---	---	---	---	---	---	---	---	---	---	---	---	---	---	-----

N: 0 = settings

N: 1 = bar codes

N: 2 = fonts

## Cancel print orders

### Parameter set to cancel all active print orders

SOH	F	G	A	-	-	-	r	N	-	-	-	-	-	-	-	ETB
-----	---	---	---	---	---	---	---	---	---	---	---	---	---	---	---	-----

N: - = Cancel active print orders and delete all layout data

N: 1 = Cancel active print orders and receive new layout data

With the execution of this command:

- possible upcoming errors are confirmed
- possible upcoming customized entries are cancelled

## 9.14 Emulation

### Set emulation

SOH	F	Z	-	-	-	-	r	N	-	-	-	-	-	-	ETB
-----	---	---	---	---	---	---	---	---	---	---	---	---	---	---	-----

N: 0 = CVPL (Carl Valentin Programming Language)

N: 1 = ZPL II® (Zebra Programming Language)

### Get emulation

SOH	F	Z	-	-	-	-	w	p	p	p	p	p	p	p	p	ETB
-----	---	---	---	---	---	---	---	---	---	---	---	---	---	---	---	-----

### Answer

SOH	A	N	-	-	-	-	-	p	p	p	p	p	p	p	p	ETB
-----	---	---	---	---	---	---	---	---	---	---	---	---	---	---	---	-----

## 10 Parameter Sets for C Mode

### 10.1 Machine Parameters

#### Set operating mode

```
SOH F C D C - - r N - - - - - - ETB
```

N: 1 = external I/O static  
 N: 3 = external I/O static continuous  
 N: 5 = external I/O dynamic  
 N: 6 = external I/O dynamic continuous

#### Get operating mode

```
SOH F C D C - - w p p p p p p p p ETB
```

#### Answer

```
SOH A N - - - - - - p p p p p p p p ETB
```

#### Set print offset

```
SOH F C A D L A r N N N N N - - M ETB
```

NNNNN: print offset value  
 M: unit - 0 = print offset in 1/10 mm (00000 ... 09999)  
       1 = print offset in 1/10 ms (00000 ... 99999)

#### Get print offset

```
SOH F C A D L A w p p p p p p p p ETB
```

#### Answer

```
SOH A N N N N N - - M p p p p p p p p ETB
```

NNNNN: print offset value  
 M: unit - 0 = print offset in 1/10 mm  
       1 = print offset in 1/10 ms

#### Set material speed at print start signal

```
SOH F C A D U D r N - - - - - - ETB
```

N: 0 = Off  
 N: 1 = On

#### Get material speed at print start signal

```
SOH F C A D U D w p p p p p p p p ETB
```

#### Answer

```
SOH A N - - - - - - p p p p p p p p ETB
```

N: 0 = Off  
 N: 1 = On

**Set encoder resolution**

SOH F C A D U A r N N N N - - - - ETB

N: value of encoder resolution (0100 ... 9999)

**Get encoder resolution**

SOH F C A D U A w p p p p p p p p ETB

**Answer**

SOH A N N N N - - - - p p p p p p p p ETB

**Set material feed per encoder turn**

SOH F C A D U B r N N N N - - - - ETB

N: value of material feed in mm (0010 ... 9999)

**Get material feed per encoder turn**

SOH F C A D U B w p p p p p p p p ETB

**Answer**

SOH A N N N N - - - - p p p p p p p p ETB

**Get material speed**

SOH F C A D U C w p p p p p p p p ETB

By means of this command set it is possible to enquire material speed in mm/s. Please note that it is only possible to enquire the value and not to set.

**Answer**

SOH A N N N N - - - - p p p p p p p p ETB

## 10.2 I/O Parameters

### Set IN signal level

SOH	F	C	M	D	C	-	r	1	2	3	4	5	6	7	8	ETB
-----	---	---	---	---	---	---	---	---	---	---	---	---	---	---	---	-----

1-8 (inputs 1-8): 2 = increased and decreased

1 = increased

0 = decreased

s = I/O signal by interface

x = I/O signal blocked

### Get signal level

SOH	F	C	M	D	C	-	w	p	p	p	p	p	p	p	p	ETB
-----	---	---	---	---	---	---	---	---	---	---	---	---	---	---	---	-----

### Answer

SOH	A	0	1	2	3	4	5	6	7	p	p	p	p	p	p	p	ETB
-----	---	---	---	---	---	---	---	---	---	---	---	---	---	---	---	---	-----

### Set OUT signal level

SOH	F	C	M	D	D	-	r	1	2	3	4	5	6	7	8	ETB
-----	---	---	---	---	---	---	---	---	---	---	---	---	---	---	---	-----

1-8 (outputs 1-8): 1 = signal level 1

0 = signal level 0

s = I/O signal by interface

x = I/O signal blocked

### Get OUT signal level

SOH	F	C	M	D	D	-	w	p	p	p	p	p	p	p	p	ETB
-----	---	---	---	---	---	---	---	---	---	---	---	---	---	---	---	-----

### Answer

SOH	A	0	1	2	3	4	5	6	7	p	p	p	p	p	p	p	ETB
-----	---	---	---	---	---	---	---	---	---	---	---	---	---	---	---	---	-----

### Set software input

SOH	F	C	M	D	F	-	r	1	2	3	4	5	6	7	8	ETB
-----	---	---	---	---	---	---	---	---	---	---	---	---	---	---	---	-----

1-8 (inputs 1-8): 1 = set software input

0 = delete software input

- = not considering software input

P = pulse, execute software input once

**Example:** Auslösen eines Startimpulses = FCMDF-rP-----

### Get current status of software inputs

SOH	F	C	M	D	F	-	w	p	p	p	p	p	p	p	p	ETB
-----	---	---	---	---	---	---	---	---	---	---	---	---	---	---	---	-----

### Answer

SOH	A	0	1	2	3	4	5	6	7	p	p	p	p	p	p	p	ETB
-----	---	---	---	---	---	---	---	---	---	---	---	---	---	---	---	---	-----

**Set software output**

SOH F C M D G - r 1 2 3 4 5 6 7 8 ETB

1-8 (outputs 1-8): 1 = set software output  
0 = delete software output

**Set start signal delay**

SOH F C S D D - r N N N - - - - ETB

NNN: start signal delay in 1/100 s (0...999)

**Get start signal delay**

SOH F C S D D - w p p p p p p p p ETB

**Answer**

SOH A N N N - - - - p p p p p p p p ETB

**Set cancel continuous print (operating mode)**

SOH F C S D F A r N - - - - - - ETB

N: 0 = Offs

N: 1 = On

**Get cancel continuous print (operating mode)**

SOH F C S D F A w p p p p p p p p ETB

**Answer**

SOH A N - - - - - - p p p p p p p p ETB

**Set output signal 'print ready' active**

SOH F C S D J - r N - - - - - - ETB

N: 0 = Off; at print start the 'print ready' signal is inactive.

N: 1 = On; at print start the 'print ready' signal remains active.

**Get output signal 'print ready' active**

SOH F C S D J - w p p p p p p p p ETB

**Answer**

SOH A N - - - - - - p p p p p p p p ETB

N: current setting (see above)

## 11 Parameter Sets for I Mode

### 11.1 Machine Parameters

#### Set operating mode

```
SOH F C A D H - r N - - - - - ETB
```

N: 1 = process single items

N: 2 = continuous

#### Get operating mode

```
SOH F C A D H - w p p p p p p p p ETB
```

#### Answer

```
SOH A N - - - - - p p p p p p p p ETB
```

N: current operating mode

#### Set print speed

```
SOH F C A A - - r N N N - - - - - ETB
```

NNN: Indication of print speed in mm/s

It is necessary to transmit a 3 digit ASCII number.

#### Get print speed

```
SOH F C A A - - w p p p p p p p p ETB
```

#### Answer

```
SOH A N N N - - - - - p p p p p p p p ETB
```

#### Set back speed

```
SOH F C A D G - r N N N - - - - - ETB
```

NNN: indication of back speed in mm/s (050 ... 400)

#### Get back speed

```
SOH F C A D G - w p p p p p p p p ETB
```

#### Answer

```
SOH A N N N - - - - - p p p p p p p p ETB
```

NNN: current back speed

**Set print offset**

SOH F C A D L - r N N N N - - - - ETB

NNNN: print offset in 1/10 mm (0000...9999)

**Get print offset**

SOH F C A D L - w p p p p p p p p ETB

**Answer**

SOH A N N N N N - - - - p p p p p p p p ETB

NNNN: current print offset

**Set ribbon save On/Off**

SOH F C D J - - r N - - - - - - - - ETB

N: 0 = Off

N: 1 = On

**Get ribbon save On/Off**

SOH F C D J - - w p p p p p p p p ETB

**Answer**

SOH A N - - - - - - - - p p p p p p p p ETB

## 11.2 I/O Parameters

### Set IN signal level

SOH	F	C	M	D	C	-	r	1	2	3	4	5	6	7	8	ETB
-----	---	---	---	---	---	---	---	---	---	---	---	---	---	---	---	-----

1-8 (inputs 1-8): 2 = increased and decreased

1 = increased

0 = decreased

s = I/O signal by interface

x = I/O signal blocked

### Get signal level

SOH	F	C	M	D	C	-	w	p	p	p	p	p	p	p	p	ETB
-----	---	---	---	---	---	---	---	---	---	---	---	---	---	---	---	-----

### Answer

SOH	A	0	1	2	3	4	5	6	7	p	p	p	p	p	p	ETB
-----	---	---	---	---	---	---	---	---	---	---	---	---	---	---	---	-----

### Set OUT signal level

SOH	F	C	M	D	D	-	r	1	2	3	4	5	6	7	8	ETB
-----	---	---	---	---	---	---	---	---	---	---	---	---	---	---	---	-----

1-8 (outputs 1-8): 1 = signal level 1

0 = signal level 0

s = I/O signal by interface

x = I/O signal blocked

### Get OUT signal level

SOH	F	C	M	D	D	-	w	p	p	p	p	p	p	p	p	ETB
-----	---	---	---	---	---	---	---	---	---	---	---	---	---	---	---	-----

### Answer

SOH	A	0	1	2	3	4	5	6	7	p	p	p	p	p	p	ETB
-----	---	---	---	---	---	---	---	---	---	---	---	---	---	---	---	-----

### Set I/O protocol port

SOH	F	C	M	D	E	-	r	T	C	P	-	-	-	-	ETB
-----	---	---	---	---	---	---	---	---	---	---	---	---	---	---	-----

Port: Off

COM1

COM2

TCP

### Get I/O protocol port

SOH	F	C	M	D	E	-	w	p	p	p	p	p	p	p	p	ETB
-----	---	---	---	---	---	---	---	---	---	---	---	---	---	---	---	-----

### Answer

SOH	A	0	1	2	3	-	-	-	-	p	p	p	p	p	p	ETB
-----	---	---	---	---	---	---	---	---	---	---	---	---	---	---	---	-----

**Set software input**

SOH F C M D F - r 1 2 3 4 5 6 7 8 ETB

1-8 (inputs 1-8): 1 = set software input  
 0 = delete software input  
 - = not considering software input  
 P = pulse, execute software input once

**Example:** Enter a start impulse = FCMDF-rP-----**Get current status of software inputs**

SOH F C M D F - w p p p p p p p p ETB

**Antwort**

SOH A 0 1 2 3 4 5 6 7 p p p p p p p p ETB

**Set software output**

SOH F C M D G - r 1 2 3 4 5 6 7 8 ETB

1-8 (outputs 1-8): 1 = set software output  
 0 = delete software output

**Set debounce start signal**

SOH F C S D C - r N N N - - - - ETB

NNN: debounce time start signal in ms (0...100)

**Get debounce start signal**

SOH F C S D C - w p p p p p p p p ETB

**Answer**

SOH A N N N - - - - p p p p p p p p ETB

**Set start signal delay**

SOH F C S D D - r N N N - - - - ETB

NNN: start signal delay in 1/100 s (0 ... 999)

**Get start signal delay**

SOH F C S D D - w p p p p p p p p ETB

**Answer**

SOH A N N N - - - - p p p p p p p p ETB

**Get cancel continuous print (operating mode)**

SOH F C S D F A w p p p p p p p p ETB

**Answer**

SOH A N - - - - - p p p p p p p p ETB

**Set output signal 'print ready' active**

SOH F C S D J - r N - - - - - ETB

N: 0 = Off; at print start the 'print ready' signal is inactive.

N: 1 = On; at print start the 'print ready' signal remains active.

**Get output signal 'print ready' active**

SOH F C S D J - w p p p p p p p p ETB

**Answer**

SOH A N - - - - - p p p p p p p p ETB

N: current setting (see above)



## 12 Configuration & Status

### Save configuration permanent

In case you want to save the described settings permanent into the printing system, then you have to transmit the following command to the printing system.

```
SOH F X - - - - r N - - - - - - - - ETB
```

N: 0 = save current parameter

N: 1 = set all parameters to default values

Then the print module performs a restart

### Read configuration

```
SOH F X - - - - w - - - - - - - - ETB
```

The printing system sends as answer all current settings as parameter sets.

### Status enquiry

Host computer can receive information about the printing system by the serial interface.

The status enquiry has the following data format:

```
SOH S ETB
```

### Status return information

After receiving the status enquiry the printing system sends the corresponding status return information.

### Data format of status enquiry

```
SOH 1. Byte          2. Byte          5.-1. digit ETB
      8 7 6 5 4 3 2 1 8 7 6 5 4 3 2 1
```

1. Byte	=	1. Status byte
		8. Bit = free
		7. Bit = always set
		6. Bit = free
		5. Bit = 1 = running print order 0 = no. of items (0 = no print order)
		4. Bit = 1 = press stop key 0 = not pressed stop key
		3. Bit = cutter error (0 = no error; 1 = error)
		2. Bit = layout material (0 = no error; 1 = error)
		1. Bit = transfer ribbon (0 = no error; 1 = error)
2. Byte	=	2. Status byte
		8. - 4. Bit = free
		3. Bit = Compact Flash card
		2. Bit = Mask set
		1. Bit = Printhead temperature
5.-1. digit	=	number of pieces with 5 digits as ASCII characters min. '00000' / max. '65535'

## 12.1 Autostatus

The direct printing systems are equipped with an auto status function, i.e. in certain operating modes the printing system actively sends the corresponding status. This can be enquired by the serial interface.

To activate the auto status, the host computer has to send the following command to the printing system:

```
SOH G 1. Byte 2. Byte ETB
```

Each of the below indicated message which is observed and send by the printing system has to be transmitted with a set Bit (see table below 1. Byte and 2. Byte) to the printing system by means of auto state function. The printing system sends after each performed condition the corresponding message (answer) to the host computer.

The following messages are provided:

### 1 Start of generation

### 2 End of generation

The printing system sends this state in case data for a complete layout was generated. The test print was not taken into consideration.

For counters/date variables the printing system sends for each layout a status cycle (start, end).

### 3 Start of printing

### 4 End of printing

The start of the print is send in case the generated data is send.

The end of the print is send in case the print of the layout is finished and the motor has stopped.

### 5 Start of cutting

### 6 End of cutting

This status describes the cutting. It can be checked for timeout and the end of the cut movement → error.

### 7 Start of feeding

### 8 End of feeding

This status is send in case an additional feeding (dispenser, cutter, tear off) is released.

### 9 Start of a print order

### 10 End of print order

This status signalizes the start and end of a complete print order (1 ... 99999 layouts). This status is active in all operating modes.

### 11 Error

This status message is send in case an error occurs.

The printing system sends the auto status in the following format to the host computer:

SOH	G	1. Byte	2. Byte	ETB
-----	---	---------	---------	-----

### 1. Byte

- |                              |                        |
|------------------------------|------------------------|
| 8. Bit = start of generation | 4. Bit = start cutting |
| 7. Bit = end of generation   | 3. Bit = end of cut    |
| 6. Bit = start printing      | 2. Bit = start feeding |
| 5. Bit = end of print        | 1. Bit = always 0      |

### 2. Byte

- |                               |                   |
|-------------------------------|-------------------|
| 8. Bit = end of layout feed   | 4. Bit = free     |
| 7. Bit = start of print order | 3. Bit = free     |
| 6. Bit = end of print order   | 2. Bit = free     |
| 5. Bit = error                | 1. Bit = always 0 |



### NOTICE!

Bit 1 has to be in 1. Byte and 2. Byte always 0, otherwise the printing system possibly could recognize SOH or ETB.

At the status message of the printing system to the host computer always at least 1 Bit is set. However, it could be occur that several Bits are set at the same time.

At the status demand of the host computer to the printing system it is also possible that several Bits are set at the same time.

The auto status demand is saved in the printing system, i.e. it is set to 0 after switching off/on. Therefore it is necessary to demand it anew after each time the printing system is switched on.

### Example

The printing system should observe the start of a print order. For this the host computer sends the following demand to the printing system.

SOH	G	00000000	01000000	ETB
-----	---	----------	----------	-----

After the condition is fulfilled (= start of the print order) the printing system sends the following message to the host computer:

SOH	G	00000000	01000000	ETB
-----	---	----------	----------	-----

With regard to the contents the answer corresponds always to the format set.



## 13 Monitored Printing

This protocol replaces the outdated Autostatus. In contrary to the Autostatus, this is not a binary protocol but a text-based protocol sending the commands as English clear text. The advantage is a very fast and simple error tracing and development. The disadvantage of a larger data volume plays nowadays a smaller role.

### 13.1 Short Introduction

In order to activate monitored printing:

(SOH)FHM---rSE(ETB)

(SOH)FHA---r2(ETB)

### 13.2 Parameter Sets (Host – Printer)

Formatting: # - SOH \* - ETB

**Command:** Set monitoring mode.

**Syntax:** #FHM---rSEPnnnCnFn\*

**Example:** #FHM---rSP10E\*

**Description:** Activates the forwarding of certain events to the server. The results are:

S - (start/stop): print start, print end, stop printing, continue printing, cancel printing.

E – (error): Error occurred, error confirmed.

C – (photocell): Activates the photocell test (n=1)/disable (n=0)

F – Activates the encoder profile (n=1)/disable (n=0)

P – (progress): Print progress, indicates the number of already printed labels. In standard case, the interval between two events is a label. If a number behind the flag is indicated, an event every *nnn* labels is released (see example). With column printing the event is released, as soon as the entered interval was reached or exceeded for the first time (example: 3 columns, interval 4, 20 labels in total. Event at label 6,9,12 and 18).

**Command:** Activate, disable the monitoring.

**Syntax:** #FHA---rn\*

**Example:** #FHA---r2\*

**Description:** activated, deactivates the monitoring (n=[0,2]);

,0' – enables the monitoring after completion of print order,

,1' – reserved

,2' – activates the monitoring for the current port.

### 13.3 Direct Enquiry

**Command:** Requests print status.

**Syntax:** #FHS---r\*

**Example:** #FHS---r\*

**Description:** Invites the client to send the current status.

**Command:** User command to the sender of print order.

**Syntax:** #FHU---rDaten\*

**Example:** #FHU---rSE\*

**Description:** Sends #Data\* to the sender of print order.  
Max 100 characters.

### 13.4 Answer Sets (Printer – Host)

**Event:** Print start

**Set:** #HSStart-*Pagename-Labelsrequested\**

**Example:** #HSStart-NoName1-100\*

**Description:** Indicates the start of a print order, including page name and number of labels to be printed.

**Event:** Printing completed

**Set:** #HSDone-*Pagename-Labelsprinted\**

**Example:** #HSDone-NoName1-100\*

**Description:** Indicates the completion of a print order including page name and number of printed labels.

**Event:** Printing stopped

**Set:** #HSHold-*Pagename-Labelsprinted\**

**Example:** #HSHold-NoName1-10\*

**Description:** Indicates the stopping of print order including page name and number of printed labels. Occurs when the user stopped the print order and/or after occurrence of an error.

**Event:** Continue printing

**Set:** #HSContinue-*Pagename-Labelsprinted\**

**Example:** #HSContinue-NoName1-55\*

**Description:** Indicates the continuation of print order including page name and number of printed labels. Occurs when the user restarts the print order.

**Event:** Cancel printing

**Set:** #HSAborted-*Pagename-Labelsprinted\**

**Example:** #HSAborted-NoName1-57\*

**Description:** Indicates the cancelation of printing including page name and number of printed labels.

**Event:** Error**Set:** #HSError-*Pagename-Labelsprinted-ErrorID-Errormessage*\***Example:** #HSError-NoName1-57-28-Messerfehler\***Description:** Indicates the occurrence of an error including page name, number of printed labels, error ID and error text.**Event:** Error confirmation at printer**Set:** #HSAck-*Pagename-Labelsprinted* \***Example:** #HSAck-NoName1-57\***Description:** Indicates the confirmation of an error including page name and number of printed labels.**Event:** Print progress**Set:** #HSProgress-*Pagename-Labelsprinted* \***Example:** #HSProgress-NoName1-60\***Description:** Indicates the progress of print order including page name and number of printed labels. This event is also returned as answer to status enquiry, if the printer is printing.**Event:** Photocell value**Set:** #HSPhotocell-DLS:xxx-RLS:xxx\***Example:** #HSPhotocell-DLS:3.8-RLS:1.9\***Description:** Returns the values of transmission and reflexion photocell. The verification takes place every 5 ms; only changes are sent.**Event:** Encoder profile**Set:** # HSEnc-Dist:xxx-Speed:xxx\***Example:** # HSEnc-Dist:120-Speed:202\***Description:** Generates the profile of speed development of the packaging machine during a print order.**Event:** Answer to status enquiry (#FHS---r\*)**Description:** The respective current print event is returned.

## 13.5 Sample Label

A simple label with monitoring of all parameters with output of the progress – all 10 labels could look as following:

```
FHM---rSP10E
//Ueberwachung einschalten
FHA---r2
// JOBNAME: "ETIKETT1"
FBE---rETIKETT1
// TYPE: Endlosetiketten
// HEIGHT: 20.00 mm
// GAPLENGTH: 2.00 mm
// COLUMNS: 1
// COLUMN DISTANCE: 100.00 mm
FCDA--r1-----
FCCL--r0002000-
FCCM--r00000---
FCCHA-r1-----
FCCHB-r999-----
// SPEED: 50 mm/s
FCAA--r050-----
// CONTRAST: 200%
FCAB--r200-----
// LABELCONTROL: 0
FCDE--r0-----
// RIBBONCONTROL: 1
// RIBBONSENS: 0
FCDB--r10-----
// MATERIAL: Typ 1
FCDNA-r0-----
FCDNB-r1-----
FCDNC-r0000----
// SCAN MODE: 0
// SCAN PORT: 0
// NO READ: 0
// FEED LABEL: 0
FCDM--r0000----
// MIRROR LABEL: Nein
FCDO--r0-----
// TEXT (1/100 mm)
AM[1]1407;6907;0;4;0;3;398;398;8
BM[1]Test
// SETLINENO: 1 lines
FBAA--r1
// SETCOPIES: 1
FBBA--r00050---
// PRINT
FBC---r-----
```

The server output, for example, looks as follows:

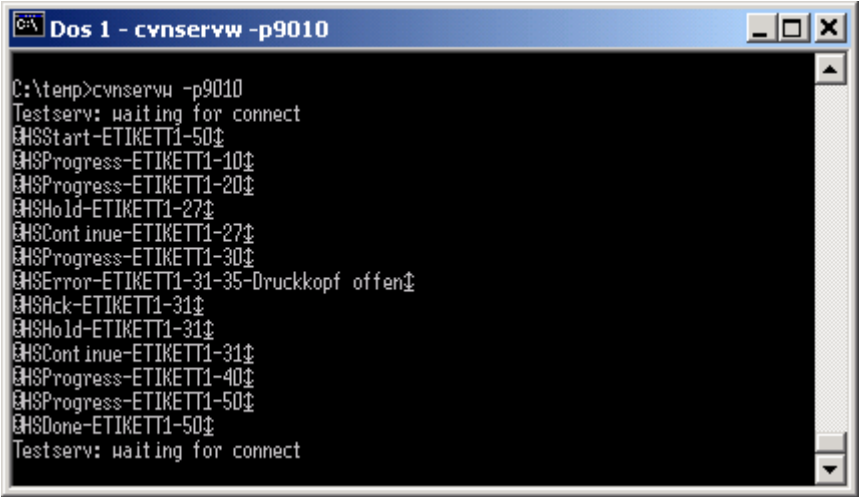

```
Dos 1 - cvnservw -p9010
C:\temp>cvnservw -p9010
Testserv: waiting for connect
@MSstart-ETIKETT1-50
@MSProgress-ETIKETT1-10
@MSProgress-ETIKETT1-20
@MSHold-ETIKETT1-27
@MSContinue-ETIKETT1-27
@MSProgress-ETIKETT1-30
@MSError-ETIKETT1-31-35-Druckkopf offen
@MSAck-ETIKETT1-31
@MSHold-ETIKETT1-31
@MSContinue-ETIKETT1-31
@MSProgress-ETIKETT1-40
@MSProgress-ETIKETT1-50
@MSDone-ETIKETT1-50
Testserv: waiting for connect
```

## 14 Font Examples

### 14.1 Bitmap Fonts (Not Proportional)

Font 01 (8 x 11) Verhältnis 3:3  
 Font 02 (12 x 17) Verhältnis 3:3  
 Font 03 (18 x 26) Verhältnis 2:2  
 Font 04 (40 x 56) Verhältnis 1:1  
 Font 05 (18 x 32 mit Unterlängen) Verhältnis 2:2  
 Font 07 (12 x 22 mit Unterlängen) Verhältnis 2:2

### 14.2 Bitmap Fonts (Proportional)

Font 21 ( 10 proportional) Verhältnis 3:3  
 Font 22 (18 proportional) Verhältnis 2:2  
 Font 23 (26 proportional) Verhältnis 2:2  
 Font 24 (56 proportional) Verhältnis 1:1  
 Font 28 (40 proportional) Verhältnis 1:1  
 Font 29 (8 proportional) Verhältnis 5:5

### 14.3 Vector Fonts

Absender (Baskerville)      Das ist ein Musteretikett  
    für die Darstellung der  
 Gold, Petra (Swiss Light)      Schriftarten (Monospace)

Name, Vorname (Helvetica Bold)  
 Goldstraße 456 (Swiss Light)

Straße, Hausnummer (Helvetica Bold)

23456 Golddorf (Swiss Light)  
PLZ, Ort (Helvetica Bold)

*Musterlieferung*  
*Bitte bestätigen Sie*  
*den Empfang. (Brush Script)*

Empfänger (Baskerville)

Mustermann, Max (Helvetica Roman)  
Name, Vorname (Helvetica Bold)

Musterstraße 123 (Helvetica Roman)  
Straße, Hausnummer (Helvetica Bold)

45678 Musterstadt (Helvetica Roman)  
PLZ, Ort (Helvetica Bold)



## 15 Index

### #

*FBAA, line number .....	55
*FBAA, number of lines.....	84
*FBBA, total items of print order .....	85
*FBBB, layouts still to print.....	85
*FBBC, already printed layouts.....	85
*FBC, start printing.....	86
*FBE, start printing (assign printjob identifier) .....	86
*FBF, initialisation of page handling .....	86
*FBG, selection of current page.....	86
*FBH, order of pages .....	86
*FBI, generation of page w/o print start .....	86
*FCAA, print speed .....	57, 93
*FCAB, contrast .....	54
*FCADG, back speed.....	57
*FCADG, back speed (intermittent mode) .....	93
*FCADH, operating mode .....	57
*FCADH, operating mode (intermittent mode).....	93
*FCADI, layouts/cycle .....	53
*FCADK, print position .....	58
*FCADL, print offset .....	57
*FCADL, print offset (intermittent mode).....	94
*FCADLA, print offset.....	71
*FCADLA, print offset (continuous mode).....	89
*FCADO, operating mode .....	58
*FCADUA, encoder resolution (continuous mode) .....	90
*FCADUB, material feed (continuous mode).....	90
*FCADUC, material speed (continuous mode).....	90
*FCADUD, material speed (continuous mode).....	89
*FCCB, buzzer .....	61
*FCCBB, contrast.....	61
*FCCE, x offset .....	53, 71
*FCCHA, number of columns .....	54
*FCCHB, column width .....	55
*FCCJ, alignment.....	54
*FCCK, keyboard layout .....	60
*FCCL, layout length 1/100 mm.....	53
*FCCN, codepage .....	60
*FCCO, layout width 1/100 mm .....	53
*FCCP, external print parameters.....	59
*FCDB, transfer ribbon control.....	58
*FCDC, operating mode (continuous mode).....	89
*FCDI, display language .....	59
*FCDJ, ribbon save (intermittent mode) .....	94
*FCDK, field handling.....	59
*FCDNC, material .....	54
*FCDO, flip layout .....	55
*FCDQA, transfer ribbon length.....	73
*FCDRA, ribbon save mode.....	63
*FCDRB, synchronization .....	63
*FCDRCA, printhead move down time .....	63
*FCDRDA, ribbon motor power .....	64

*FCDREA, brake power for acceleration/braking .....	64
*FCDREB, brake power during printing .....	64
*FCDRFA, feedback distance .....	63
*FCDRFB, feedback speed .....	64
*FCDS, flip/rotate layout .....	56
*FCDU, user guiding .....	60
*FCDW, hotstart .....	61
*FCDX, autoloading .....	61
*FCFF, interface parameters .....	65
*FCGC, SOH/ETB .....	65
*FCGD, data memory .....	66
*FCGEA, reaction unknown questions .....	66
*FCHA, paper counter printing system .....	75
*FCHB, paper counter printhead .....	75
*FCIA, date .....	75
*FCIB, time .....	75
*FCIG, automatic clock adjustment .....	76
*FCIH, beginning of summertime .....	77
*FCII, end of summertime .....	77
*FCIJ, time shifting .....	77
*FCKA, password .....	78
*FCKB, function group (password) .....	78
*FCKDA, password function menu .....	79
*FCKDB, password favorites menu .....	79
*FCKDC, password memory card .....	79
*FCKDD, password printing manually .....	79
*FCLA, IP address (network) .....	67
*FCLB, netmask (network) .....	67
*FCLC, gateway address (network) .....	67
*FCLD, transmission mode (network) .....	68
*FCLE, DHCP support (network) .....	68
*FCLF, print module name (network) .....	68
*FCLMB, MAC address (network) .....	68
*FCLNI, NTP server IP (network) .....	69
*FCLNS, NTP status (network) .....	70
*FCLNZ, time zone (network) .....	70
*FCLZ, reset network device (network) .....	70
*FCMBC, printhead closed .....	72
*FCMBD, printhead open .....	72
*FCMBH, compressed air sensor .....	71
*FCMBI, cover sensor .....	71
*FCMC, printhead temperature .....	73
*FCMDC, IN signal level (continuous mode) .....	91
*FCMDC, IN signal level (intermittent mode) .....	95
*FCMDD, OUT signal level (continuous mode) .....	91
*FCMDD, OUT signal level (intermittent mode) .....	95
*FCMDE, I/O protocol port (intermittent mode) .....	95
*FCMDF, software input (continuous mode) .....	91
*FCMDF, software input (intermittent mode) .....	96
*FCMDG, software output (continuous mode) .....	92
*FCMDG, software output (intermittent mode) .....	96
*FCMG, printhead resistance .....	74
*FCMH, reset error .....	84
*FCMHA, error ID/error text .....	84
*FCMKC, online/offline .....	72
*FCMKD, reprint action .....	72
*FCMKE, standard layout .....	62

*FCMLA, ribbon prior warning .....	73
*FCMLB, ribbon prior warning diameter .....	73
*FCMLC, ribbon diameter .....	74
*FCMLDA, mode (ribbon prior warning) .....	74
*FCMQ, status print .....	87
*FCNRA, custom logo.....	74
*FCSDC, debounce start signal (intermittent mode) .....	96
*FCSDDD, start signal delay (continuous mode) .....	92
*FCSDDD, start signal delay (intermittent mode).....	96
*FCSDFA, continuous print (continuous mode).....	92
*FCSDFA, continuous print (intermittent mode) .....	97
*FCSDFC, layout change confirmation.....	62
*FCSDFD, print after measuring.....	62
*FCSDJ, output signal (continuous mode).....	92
*FCSDJ, output signal (intermittent mode) .....	97
*FD, start/stop command .....	84
*FE, feed .....	87
*FEB, ribbon feed.....	87
*FF, test print .....	87
*FGA, cancel print order .....	87
*FMA, save layout (cf card).....	80
*FMB, load file (cf card) .....	80
*FMC, delete layout (cf card) .....	80
*FMD, format (cf card) .....	80
*FMG, table of contents (cf card).....	80
*FMH, memory space (cf card).....	81
*FMI, create directory (cf card) .....	81
*FMJ, delete directory (cf card).....	81
*FMJA, delete directory path (cf card) .....	81
*FMK, change directory (cf card).....	81
*FMKB, standard directory via I/O (cf card) .....	82
*FML, transfer file (cf card) .....	82
*FMM, enquiry if the file exists (carte cf).....	82
*FMP, size of cf card.....	82
*FMS, drive status (cf card) .....	83
*FZ, emulation.....	88

**A**

alignment, layout .....	54
autoload.....	61

**B**

back speed .....	57
back speed (intermittent mode).....	93
brake power	
during printing .....	64
for acceleration/braking .....	64
buzzer.....	61

**C**

clock adjustment, automatical	
beginning of summertime .....	77
end of summertime .....	77
time shifting.....	77
codepage.....	60

column	
number, column printing .....	54
width, column printing .....	55
compact flash card	
change directory .....	81
create directory .....	81
delete directory .....	81
delete directory path .....	81
delete layout .....	80
drive status .....	83
enquiry if the file exists .....	82
format card .....	80
load file .....	80
readout free memory space .....	81
save label .....	80
size of cf card .....	82
standard directory via I/O .....	82
transfer file .....	82
compressed air sensor .....	71
configuration and status	
autostatus .....	100, 101
saving .....	99
status enquiry .....	99
status return information .....	99
continuous mode (parameter sets)	
I/O parameters .....	91, 92
machine parameters .....	89, 90
continuous print (continuous mode) .....	92
continuous print (intermittent mode) .....	97
contrast .....	54, 61
cover sensor .....	71
custom logo .....	74

## D

data format	
explanation .....	12
field attributes .....	13
field name .....	14, 15, 16, 17, 18
field properties .....	13
general information .....	11
Data format	
Field selection .....	18
data memory .....	66
date/time	
automatic clock adjustment .....	77
automatical clock adjustment .....	76
date .....	75
time .....	75
datum point (text, bar code, graphic) .....	9
debounce start signal (intermittent mode) .....	96
device settings	
autoload .....	61
buzzer .....	61
codepage .....	60
contrast .....	61
display language .....	59
external print parameters .....	59
field handling .....	59

hotstart .....	61
keyboard layout .....	60
layout change confirmation .....	62
operating mode .....	58
print after measuring .....	62
print position .....	58
standard layout .....	62
transfer ribbon control .....	58
user guiding .....	60
DHCP support, network .....	68
display brightness .....	61
display language .....	59

**E**

emulation .....	88
encoder resolution (continuous mode) .....	90
external print parameters .....	59

**F**

feed .....	87
feedback distance .....	63
feedback speed .....	64
field handling .....	59
font examples	
bitmap fonts (not proportional) .....	107
bitmap fonts (proportional) .....	107
vector fonts .....	107
format identifier, date/time .....	41, 42

**G**

gateway address, network .....	67
generation, selected page .....	86
graphic set	
general graphic format .....	35
PCX format .....	35, 36

**H**

hotstart .....	61
----------------	----

**I**

I/O parameters (continuous mode)	
continuous print .....	92
IN signal level .....	91
OUT signal level .....	91
output signal .....	92
software input .....	91
software output .....	92
start signal delay .....	92
I/O parameters (intermittent mode)	
continuous print .....	97
debounce start signal .....	96
I/O protocol port .....	95
IN signal level .....	95
OUT signal level .....	95
output signal .....	97
software input .....	96
software output .....	96
start signal delay .....	96

I/O protocol port (intermittent mode) .....	95
IN signal level (continuous mode) .....	91
IN signal level (intermittent mode) .....	95
initialisation of page handling .....	86
interface	
parameters .....	65
SOH/ETB .....	65
intermittent mode (parameter sets)	
I/O parameters .....	95, 96, 97
machine parameters .....	93, 94
IP address, network .....	67

## K

keyboard layout .....	60
-----------------------	----

## L

layout	
flip layout .....	55
flip/rotate .....	56
rotate layout .....	55
layout change confirmation .....	62
layout length in 1/100 mm .....	53
layout parameters	
alignment .....	54
column width .....	55
contrast .....	54
flip layout .....	55
flip/rotate layout .....	56
layout length in 1/100 mm .....	53
layout width in 1/100 mm .....	53
layouts/cycle .....	53
material .....	54
number of columns .....	54
number of lines .....	55
rotate layout .....	55
x offset .....	53
layout width in 1/100 mm .....	53
line number .....	84
lines (number), column printing .....	55

## M

MAC address .....	69
machine parameters	
back speed .....	57
operating mode .....	57
print offset .....	57
print speed .....	57
machine parameters (continuous mode)	
encoder resolution .....	90
material feed .....	90
material speed .....	89, 90
operating mode .....	89
print offset .....	89
machine parameters (intermittent mode)	
back speed .....	93
operating mode .....	93
print offset .....	94
print speed .....	93
ribbon save .....	94

mask set	
bar code Aztec Code .....	30
bar code CODABLOCK F .....	27
bar code DataMatrix .....	25
bar code GS1 DataMatrix .....	26
bar code ITF .....	22
bar code MAXICODE.....	24
bar code PDF417.....	23
bar code QR Code.....	29
bar code, GS1 DataBar (RSS) .....	28
bar code, one-dimensional .....	21
internal graphic .....	32
line .....	31
rectangle .....	31
text.....	19, 20
material feed/encoder turn (continuous mode) .....	90
material selection .....	54
material speed (continuous mode).....	89, 90
monitored printing.....	103, 104, 105, 106

## N

netmask, network .....	67
network	
DHCP support.....	68
gateway address.....	67
IP address.....	67
MAC address .....	69
netmask .....	67
NTP server IP .....	69
NTP status .....	70
print module name .....	68
reset network device.....	70
time zone (hour offset).....	70
transmission mode.....	68
NTP server IP.....	69
NTP status.....	70

## O

offset values	
print offset .....	71
x offset .....	71
online/offline .....	72
operating mode .....	57, 58
operating mode (continuous mode) .....	89
operating mode (intermittent mode) .....	93
order (pages to print).....	86
OUT signal level (continuous mode) .....	91
OUT signal level (intermittent mode).....	95
output signal (continuous mode).....	92
output signal (intermittent mode).....	97

## P

paper counter	
printhead.....	75
printing system.....	75
parallel data transmission, connection plan .....	7

parameter sets	
compact flash card .....	80, 81, 82, 83
data memory .....	66
date/time .....	75, 76, 77
device settings .....	58, 59, 60, 61, 62
emulation .....	88
I/O parameters (continuous mode) .....	91, 92
I/O parameters (intermittent mode) .....	95, 96, 97
interface .....	65
interface protocol .....	65
layout parameters .....	53, 54, 55, 56
machine parameters .....	57
machine parameters (continuous mode) .....	89, 90
machine parameters (intermittent mode) .....	93, 94
network .....	67, 68, 69
offset values .....	71
password .....	78, 79
password favorites menu .....	79
password function menu .....	79
password memory card .....	79
password printing manually .....	79
printing .....	84, 85, 86, 87
ribbon save .....	63, 64
service functions .....	72, 73, 74, 75
password .....	78, 79
print after measuring .....	62
print module name .....	68
print offset .....	57, 71
print offset (continuous mode) .....	89
print offset (intermittent mode) .....	94
print order, cancel .....	87
print position .....	58
print speed .....	57
print speed (intermittent mode) .....	93
printhead	
resistance .....	74
temperature .....	73
printhead closed .....	72
printhead move down time .....	63
printhead open .....	72
printing	
cancel print orders .....	87
feed .....	87
generation of selected page .....	86
initialisation of page handling .....	86
Item number of print order .....	85
number of lines .....	84
print order .....	86
reset error .....	84
ribbon feed .....	87
selection of current page .....	86
start printing .....	86
start/stop command .....	84
status printing .....	87
test print .....	87
printing, start .....	86

**R**

reaction, unknown questions .....	66
reprint action .....	72
reset error .....	84
reset network device .....	70
ribbon feed .....	87
ribbon save	
brake power during printing .....	64
brake power for acceleration/braking .....	64
feedback distance .....	63
feedback speed .....	64
printhead move down time .....	63
ribbon motor power .....	64
ribbon save mode .....	63
synchronization .....	63
ribbon save (intermittent mode) .....	94
ribbon save mode .....	63
rotation (text, bar code, graphic) .....	9

**S**

sensors	
compressed air .....	71
cover .....	71
serial data transmission	
connection plan RS232 .....	6
connector assignment .....	5
service functions	
custom logo .....	74
online/offline .....	72
printhead resistance .....	74
printhead temperature .....	73
reprint action .....	72
transfer ribbon length .....	73
transfer ribbon prior warning .....	73
transfer ribbon prior warning, diameter .....	73
transfer ribbon prior warning, mode .....	74
software input (continuous mode) .....	91
software input (intermittent mode) .....	96
software output (continuous mode) .....	92
software output (intermittent mode) .....	96
SOH/ETB .....	65
standard layout .....	62
start signal delay (continuous mode) .....	92
start signal delay (intermittent mode) .....	96
start/stop command .....	84
status print .....	87
synchronization .....	63

**T**

test print .....	87
text set	
example .....	34
general information .....	33
time zone (hour offset) .....	70
transfer ribbon control .....	58
transfer ribbon length .....	73

transfer ribbon motor power .....	64
transfer ribbon prior warning .....	73
diameter .....	73
mode .....	74
transmission mode .....	68

## U

user guiding .....	60
--------------------	----

## V

variables	
check digit .....	50
counter .....	38
counter, extended .....	39
currency variable .....	44
date/time .....	40, 41, 42, 43
EPC (electronic product code) .....	49
GS1-128 parser .....	48
link field .....	37
memory card data .....	48
set structure .....	37
shift variable .....	45
substring .....	51
user guiding .....	46
user guiding with mask .....	47
vormat identifier, date/time .....	43

## X

x offset .....	53, 71
----------------	--------





Carl Valentin GmbH  
Neckarstraße 78 – 86 u. 94  
78056 Villingen-Schwenningen  
Phone +49 7720 9712-0  
info@carl-valentin.de  
www.carl-valentin.de

