

SCANNER

Operating Manual – SICK CLV622



Copyright by Carl Valentin GmbH / 7960091.0819

Information on the scope of delivery, appearance, performance, dimensions and weight reflect our knowledge at the time of printing.

We reserve the rights to make modifications.

All rights, including those regarding the translation, are reserved.

No part of this document may be reproduced in any form (print, photocopy or any other method) or edited, copied or distributed electronically without written permission from Carl Valentin GmbH.

Due to the constant further development of our devices discrepancies between manual and device can occur.

Please check www.carl-valentin.de for the latest update.

Trademarks

All named brands or trademarks are registered brands or registered trademarks of their respective owners and may not be separately labelled. It must not be concluded from the missing labelling that it is not a registered brand or a registered trademark.



Carl Valentin GmbH

Postfach 3744
78026 Villingen-Schwenningen
Neckarstraße 78 – 86 u. 94
78056 Villingen-Schwenningen

Phone +49 7720 9712-0
Fax +49 7720 9712-9901

E-Mail info@carl-valentin.de
Internet www.carl-valentin.de

Table of Contents

1	General Notes	5
1.1	Environmentally-Friendly Disposal	5
1.2	Product Description	6
2	Technical Data	7
3	Installation of Scanner Bracket.....	9
3.1	Spectra II	9
4	Configuration	11
4.1	Settings of the Scanner Software.....	11
4.1.1	Reading Configuration	12
4.1.2	Code Configuration	13
4.1.3	Data Processing	13
4.1.4	Network/Interfaces/IOs.....	16
4.2	Saving the Settings in the Scanner	17
4.3	Loading a Configuration File	17
5	Function Menu Scanner.....	19
5.1	Scanner Mode	19
5.2	Scanner Type	20
5.3	Scanner Setup.....	20
5.4	Scan Offset.....	20
5.5	Scan Length	21
5.6	Scan Mode	21
5.7	Scan Delay	22
5.8	Scan Timeout	22
5.9	Interface Parameter	22
6	Parameter Sets for Scanner Mode.....	23
6.1	Scanner Variable	25
7	Error Messages.....	27
8	Index	29

1 General Notes

By means of the scanner option the immediate verification of printed bar codes is possible. Moreover errors such as defective printhead, transfer ribbons etc. can be avoided.

The bar code scanner is a state-of-the-art device which complies with the recognized safety-related rules and regulations. Despite this, a danger to life and limb of the user or third parties could arise and the bar code scanner or other property could be damaged while operating the device.

The bar code scanner may only be used while in proper working order and for the intended purpose. Users must be safe, aware of potential dangers and must comply with the operating instructions. Faults, in particular those which affect safety, must be remedied immediately.

1.1 Environmentally-Friendly Disposal

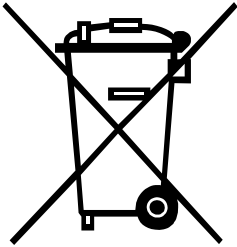

Manufacturers of B2B equipment are obliged to take back and dispose of old equipment that was manufactured after 13 August 2005. As a principle, this old equipment may not be delivered to communal collecting points. It may only be organised, used and disposed of by the manufacturer. Valentin products accordingly labelled can therefore be returned to Carl Valentin GmbH.

This way, you can be sure your old equipment will be disposed of correctly.

Carl Valentin GmbH thereby fulfils all obligations regarding timely disposal of old equipment and facilitates the smooth reselling of these products. Please understand that we can only take back equipment that is sent free of carriage charges.

The electronics board of the printing system is equipped with a battery. This must only be discarded in battery collection containers or by public waste management authorities.

Further information on the WEEE directive is available on our website www.carl-valentin.de.

1.2 Product Description



Figure 1

The CLV622 is a compact, powerful and easy-to-use bar code scanner designed for a variety of applications.

The SMART620-Code reconstruction allows accurate detection of damaged, dirty and partially dirty bar codes.

The data can be transferred to the controller in the desired format. This results in less programming effort.

Even at high conveyor speeds, the CLV622 can provide real-time code identification.

The compact design and simple operation facilitate the installation in space-critical situations.

2 Technical Data

Features	
Version	Mid range
Connection type	Cable
Reading field	Front
Scanner design	Line scanner
Focus	Fixed focus
Light source	Visible red light (655 nm)
Laser class	2 (IEC 60825-1:2014, EN 60825-1:2014)
Aperture angle	≤ 50°
Scanning frequency	400 Hz ... 1,200 Hz
Code resolution	0.2 mm ... 1 mm
Reading distance	60 mm ... 365 mm
Mechanics/electronics	
Electrical connection	1 x 15-pin D-Sub HD male connector (0.9 m)
Supply voltage	10 V DC ... 30 V DC when connecting to the printer: 24 V DC
Power consumption	4.5 W
Housing	Aluminum die cast
Housing color	Light blue (RAL 5012)
Front screen	Glass
Enclosure rating	IP65 (DIN 40 050)
Protection class	III (VDE 0106/IEC 1010-1)
Weight	225 g, with connecting cable
Dimensions (L x W x H)	61 mm x 66 mm x 38 mm
MTBF	40,000 h
Performance	
Readable code structures	1D
Bar code types	All current code types, Code 39, Code 128, Code 93, Codabar, GS1-128 / EAN 128, UPC /GTIN / EAN, 2/5 Interleaved, Pharmacode, GS1 DataBar, Telepen, MSI/Plessey
Print ratio	2:1 ... 3:1
No. of codes per scan	1 ... 20 (standard decoder) 1 ... 6 (SMART620)
No. of characters per reading interval	1 ... 500
No. of multiple readings	1 ... 99

Interfaces	
Serial	RS 232, RS 422
Function	Host, AUX
Data transmission rate	0.3 kBaud ... 115.2 kBaud, AUX: 57.6 kBaud (RS-232)
Reading pulse	automatically; via the serial interface to the printer
Optical indicators	6 LEDs (ready, result, laser, cata, CAN, LNK TX)
Acoustic indicators	Beeper/buzzer (can be switched off, can be allocated as a result indication function)
Configuration software	SOPAS ET
Ambient data	
Electromagnetic compatibility (EMV)	EN 61000-6-3 (2001-10) / EN 61000-6-2:2005
Vibration resistance	EN 60068-2-6 (1995)
Shock resistance	EN 60068-2-27 (1993)
Ambient operating temperature	0 °C ... +40 °C
Storage temperature	-20 °C ... +70 °C
Permissible relative humidity	90 %, non-condensing
Ambient light immunity	2,000 lx, on bar code

3 Installation of Scanner Bracket

3.1 Spectra II

**DANGER!**

Risk of death via electric shock!

- ⇒ Before installation/dismantling of the option scanner, disconnect the label printer from the mains supply and wait for a moment until the power supply unit has discharged.

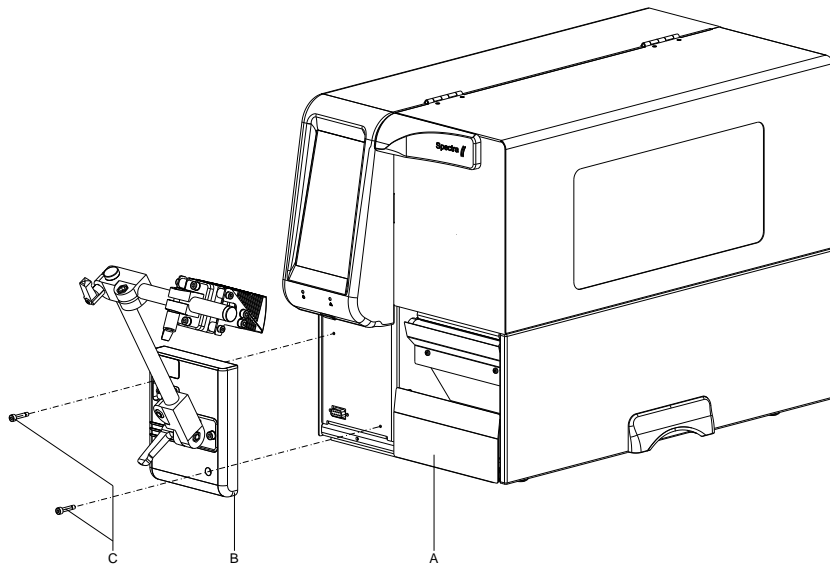

Figure 2

1. Open the right printer cover.
2. Remove the lower front panel.
3. Fasten the scanner bracket (B) with the fixing screws (C) at the printer (A).
It is important to pay attention to the plug connection!
4. Insert the label material (as described in the operating manual).

4 Configuration

The CLV622 must be configured accordingly to operate on a Spectra II. For this, the PC software *SOPAS Engineering Tool* can be downloaded from the SICK website (www.sick.com). After installing this software, the scanner must be connected via a 1:1 serial cable (D-SUB 9-pin) to the serial interface which is integrated in the scanner bracket.

Alternatively, the scanner can also be connected to an optional connection module SICK CDB620 for the configuration, and the connection to the PC can be made from there.

4.1 Settings of the Scanner Software

After starting the software SOPAS ET, it searches for the connected scanner and displays it on the user interface.

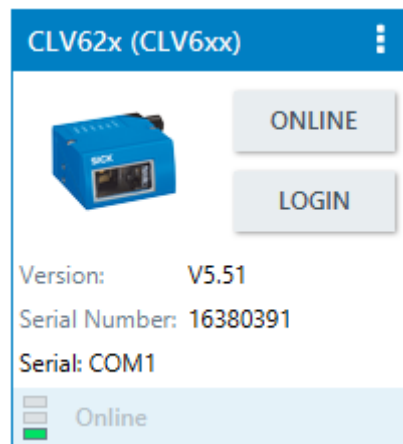

Figure 3

By double-clicking on the scanner symbol or by clicking 'Open device window ...' in the context menu, the device window is opened (standard or advanced). In the advanced display, a tree structure is displayed on the left side. Different parameter ranges can be selected there.

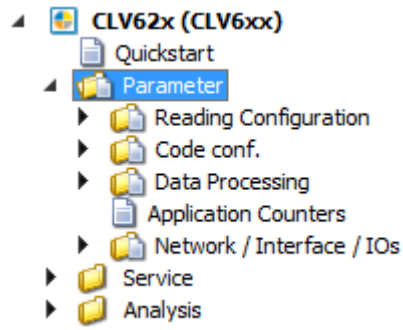

Figure 4

After selecting a parameter range, the corresponding parameters are displayed on the right side and can be changed there.

4.1.1 Reading Configuration

Object trigger control

Various settings regarding the signal to start the scanner can be made.

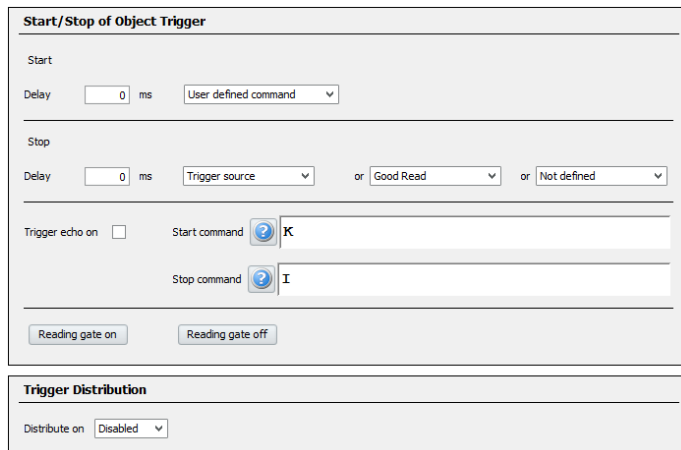

Figure 5

Do not change the setting 'Start by / User defined command' because the scanner is to be controlled by the printer which sends the start command (K) and the stop command (I).

Illumination control

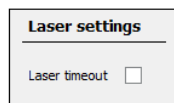
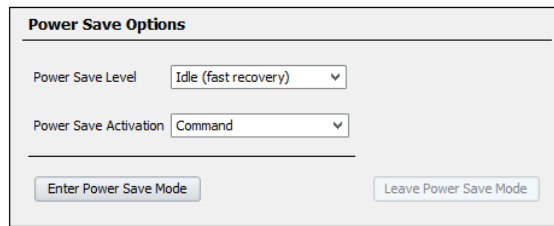

Figure 6

Normally no settings are necessary.

PowerSave control



Power Save Options

Power Save Level: Idle (fast recovery) ▼

Power Save Activation: Command ▼

Enter Power Save Mode Leave Power Save Mode

Figure 7

Normally no settings are necessary.

4.1.2 Code Configuration

Settings regarding the codes to be scanned can be made.

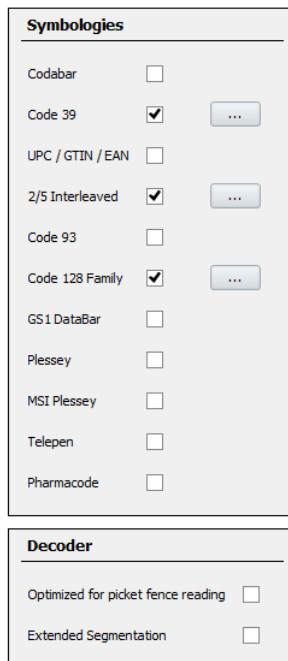

Symbologies

Codabar	<input type="checkbox"/>	
Code 39	<input checked="" type="checkbox"/>	...
UPC / GTIN / EAN	<input type="checkbox"/>	
2/5 Interleaved	<input checked="" type="checkbox"/>	...
Code 93	<input type="checkbox"/>	
Code 128 Family	<input checked="" type="checkbox"/>	...
GS1 DataBar	<input type="checkbox"/>	
Plessey	<input type="checkbox"/>	
MSI Plessey	<input type="checkbox"/>	
Telepen	<input type="checkbox"/>	
Pharmacode	<input type="checkbox"/>	

Decoder

Optimized for picket fence reading

Extended Segmentation

Figure 8

4.1.3 Data Processing

Settings for the data processing can be adjusted here.

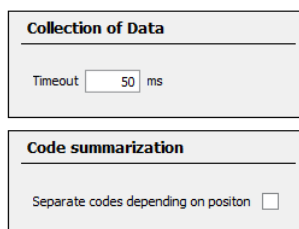

Collection of Data

Timeout: 50 ms

Code summarization

Separate codes depending on position

Figure 9

Output control

Settings for the output control can be adjusted here.

Figure 10

The default settings for the data transmission point ('as soon as possible') and the output condition ('Good Read') should not be changed.

Evaluation conditions

Figure 11

Normally no settings are necessary. At print start, the printer sends the number of codes to be scanned (min/max) to the scanner.

Matchcode Teach-In

Figure 12

Normally no settings are necessary.

Filter/sorter for the output formatting

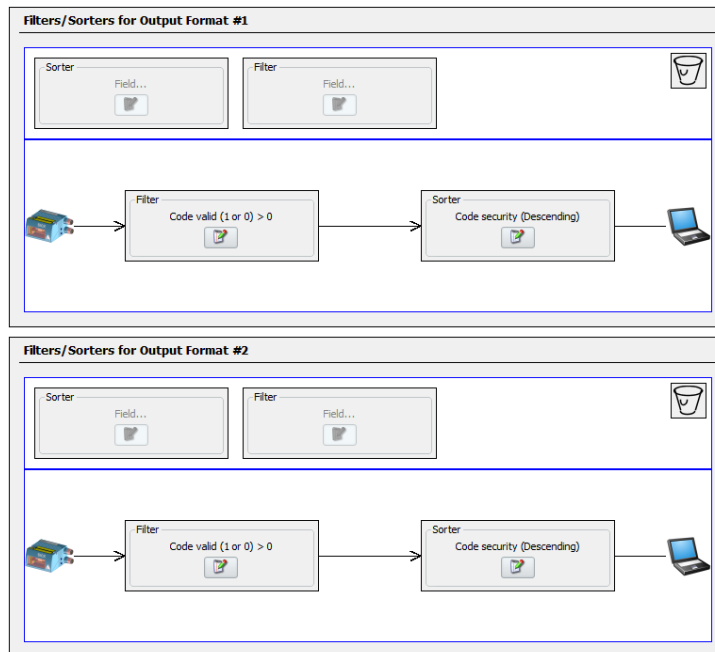

Figure 13

Normally no settings are necessary.

Output format

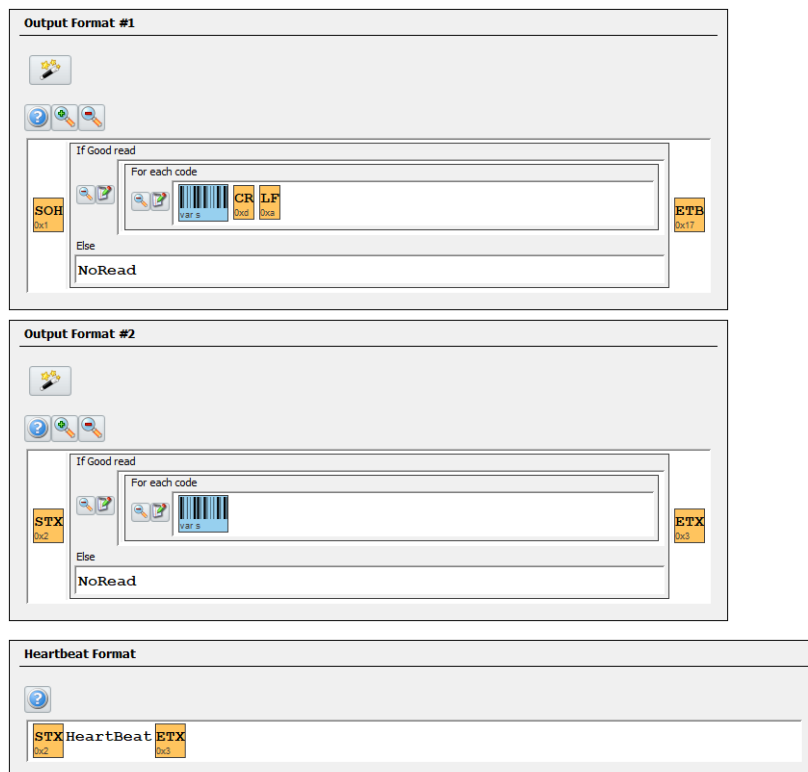

Figure 14

No changes should be made here, otherwise the communication between printer and scanner may not work.

4.1.4 Network/Interfaces/IOs

Serial

Serial Host Interface	
Protocol / Output Format	Output Format #1
Baudrate	9600
Stopbits	1
Databits / Parity	8 Databits / No Parity
Hardware	RS232
Enable Heartbeat	<input type="checkbox"/>
Handshake	none
XON/XOFF	<input type="checkbox"/>
Usage of Input Data	No External Input Data

Serial Auxiliary Interface	
Protocol / Output Format	Reading Diagnosis
Enable Heartbeat	<input type="checkbox"/>
Usage of Input Data	No External Input Data

Figure 15

The interface Serial Host is used as connection between the scanner and printer. If the interface parameters (baud rate, etc) are changed, they must be adjusted accordingly in the function menu 'Scanner' of the printer.

Digitale Eingänge

Sensor 1			
Sensitivity	Edge	Logic	Active High
Debouncing	10	ms	

Sensor 2			
Sensitivity	Edge	Logic	Active High
Debouncing	10	ms	

Figure 16

No settings are necessary as the scanner is not controlled via the digital inputs.

Digital outputs / beeper

Output 1	
On Event	Device Ready
Logic	Active High

Output 2	
On Event	Good Read
Off Event	Timer/Tracking
Evaluation time	Object trigger end
Logic	Active High
Duration	100 ms

External Output 1	
On Event	No Function
Logic	Active High
Only available on fieldbus!	

External Output 2	
On Event	No Function
Logic	Active High
Only available on fieldbus!	

Beeper	
Beeper	Good Read
Volume	Off

Figure 17

No settings are necessary as the digital outputs are not used. If necessary, the beeper can be switched on as feedback from the scanner.

4.2 Saving the Settings in the Scanner

To save the settings in the scanner, in the menu under the device name (CLV62x), select the function 'Parameter/Save permanent'. This

can also be done with clicking on the symbol .

4.3 Loading a Configuration File

To load an existing configuration file from the PC, the function 'Device/Import SDV file ...' must be selected.

After selecting the file name (*.sdv), the parameters are loaded and can be saved in the scanner as described above.

5 Function Menu Scanner

5.1 Scanner Mode

This display provides the possibility to set the desired scanner mode (Mode), the number of acceptable non-readable (NoRd) as well as the number of label feedings (Flab).

Operating mode (Mode)	0 = Off
	1 = Mode 1 (data comparison), i.e. bar code data which was read by the scanner is compared with the printed data.
	2 = Mode 2 (check readability), i.e. it is only checked if the scanner can read the printed bar codes.
	3 = Mode 3 (check readability, graphic), i.e. it is only checked if the scanner can read the printed bar codes. This mode is to use if the bar code is available as graphic (e.g. printing with printer driver). In this case the printer cannot recognize that a bar code is placed onto the label.

Non-readable (NoRd)	Indication of number of successive non readables, i.e. when the printer indicates an error message. Value range: 0 ... 9
	1 = the printer stops at the first label which cannot be red from the scanner and shows an error message.
	0 = the printer do not stop at non-readable. A message appears at the display only.

Label feed (VEti)	In many cases the scanner cannot be positioned directly on the printhead. In this case, use this parameter to set a label feed between 1 and 5. The illustration shows the meaning of this parameter.
--------------------------	---

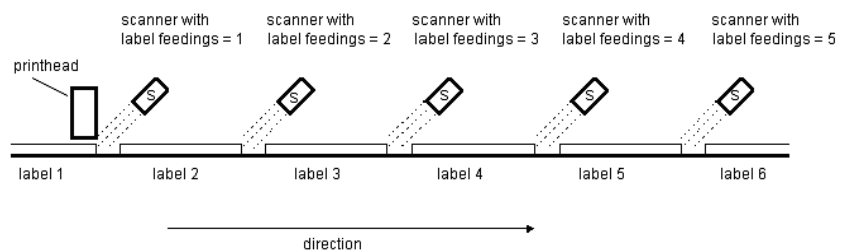

5.2 Scanner Type

The different scanners are controlled by different commands and/or the scanners return the scanned data in different manners. Therefore this window provides the possibility to select the scanner model corresponding to the connected scanner.

5.3 Scanner Setup

With this parameter, the position of the scanner can be set. However, first of all you have to connect the scanner, select the corresponding scanner model in 'scanner type' window, set the corresponding interface and correctly to set the parameters in the 'interface parameter' window.

After pressing the enter key (red button) the scanner is set to on and tries to read bar codes continuously. In case a bar code is read then the read data is indicated in the display and the scanner is immediately again set to on. Is the scanner in the correct position it starts to flicker. Is the scanner not in the correct position then it is set to on as long as again a bar code is read. The scanner is to position in the way that at feeding labels of 1 the bar code is directly read at the printhead.

5.4 Scan Offset

In scan mode 'while print' the scanner is switched On if the first pixel line is printed (= of bar code which is to scan). The scanner is switched Off either by reading the bar code (Good Read) or explicitly by the printer, if the last pixel line is printed (= of the bar code which is to scan - No Read). By means of this value the switch On and Off position of scanner in printing direction can be shifted.

In scan mode 'after print), the label is advanced by the set offset, before the scanner is switchen On and after scanning again retracted.

5.5 Scan Length

If this parameter is set to 0 (AUTO), the switch on and off position of scanner is calculated by means of position and height of bar code onto the label. If the parameter Scan Length is not 0, so this defines the length of scan sector. The start of scan sector is then set by the parameter 'Scan Offset'.

This parameter is not relevant in scan mode 'after print'

The following drawing shows the meaning of the parameters 'Scan Offset' and 'Scan length'.

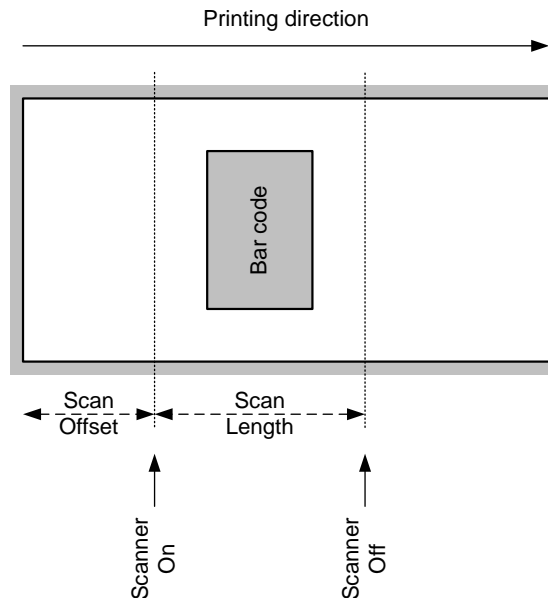

Figure 18

5.6 Scan Mode

With this parameter can be adjusted, at which time the scanning of the bar code is to be effected - during printing or after printing.

While printing The scanning of bar code is effected while the label is printed. By means of the parameter 'number of feeding labels' can be defined which label should be scanned. With the parameters 'Scan offset' and 'Scan length' the scan sector can be specified.

After printing The scanning of bar code is effected after the label was printed. With the parameter 'Scan delay' the time can be varied between printing the label and switching on the scanner. With the parameter 'Scan timeout' the time can be specified which is available for scanning the label. After successful scanning of bar code the next label is printed and/or in dispensing mode the printer changes to 'waiting' mode.

5.7 Scan Delay

In scan mode 'after print' the scanner is switched On after the label was printed. With this value the time can be specified between printing the label and switching On the scanner.

This parameter is not relevant in scan mode 'while print'.

5.8 Scan Timeout

In scan mode 'after print' can be specified with this value the time which is available for scanning the label. If the parameter 'scan timeout' is set to 0, the printer waits until the bar code could be read. If the bar code is not read within the fixed time the printer switches Off the scanner again (non readable). When reaching the fixed number of consecutive non-readable an error message appears at the display.

This parameter is not relevant in scan mode 'while print'.

5.9 Interface Parameter

Set the parameter of serial interface at which the scanner is connected to the printer.

COMx	0 = Off 1 = On 2 = On, no error message at interface errors
Baud rate	1200, 2400, 4800, 9600, 19200, 38400, 57600 Baud
P - Parity	N = None O = Odd E = Even
D – Data bits	7, 8 Bits
S – Stop bits	1, 2 Bits

6 Parameter Sets for Scanner Mode

Set scanner operating mode

SOH	F	C	D	M	-	-	r	M	P	N	F	-	-	-	-	ETB
-----	---	---	---	---	---	---	---	---	---	---	---	---	---	---	---	-----

M: 0 = Off

M: 1 = Mode 1 (data comparison)

M: 2 = Mode 2 (check only readability)

M: 3 = Mode 3 (check only readability, graphic)

P: 0 = Interface COM1

P: 1 = Interface COM2

This parameter is ignored because COM2 is always used as scanner interface

N: - = 0 bad readings (NoReads)

N: 0 = 1 bad readings

N: 1 = 2 bad readings

N: 2 = 3 bad readings

N: 3 = 4 bad readings

N: 4 = 5 bad readings

N: 5 = 6 bad readings

N: 6 = 7 bad readings

N: 7 = 8 bad readings

N: 8 = 9 bad readings

Number of consecutive bad readings after which an error message is displayed. With '-' (0 NoReads) no error message occurs, i.e. the print procedure is not interrupted. Only a warning will be shown on the display.

F: 0 = No label feed (FeedLabel)

F: 1 = Feed by 1 label

F: 2 = Feed by 2 labels

F: 3 = Feed by 3 labels

F: 4 = Feed by 4 labels

F: 5 = Feed by 5 labels

Enquire scanner operating mode

SOH	F	C	D	M	-	-	w	p	p	p	p	p	p	p	p	p	ETB
-----	---	---	---	---	---	---	---	---	---	---	---	---	---	---	---	---	-----

Answer

SOH	A	M	P	N	F	-	-	-	-	p	p	p	p	p	p	p	p	ETB
-----	---	---	---	---	---	---	---	---	---	---	---	---	---	---	---	---	---	-----

Set scan offset

SOH	F	C	D	M	A	-	r	N	N	N	N	-	-	-	-	ETB
-----	---	---	---	---	---	---	---	---	---	---	---	---	---	---	---	-----

N = Scan offset in 1/10 mm

Enquiry scan offset

SOH	F	C	D	M	A	-	w	p	p	p	p	p	p	p	p	p	ETB
-----	---	---	---	---	---	---	---	---	---	---	---	---	---	---	---	---	-----

Antwort

SOH	A	N	N	N	N	-	-	-	-	p	p	p	p	p	p	p	p	ETB
-----	---	---	---	---	---	---	---	---	---	---	---	---	---	---	---	---	---	-----

N = Current scan offset in 1/10 mm

Set scan length

SOH F C D M B - r N N N N - - - - ETB

N = Scan length in 1/10 mm

Enquiry scan length

SOH F C D M B - w p p p p p p p p ETB

Answer

SOH A N N N N - - - - p p p p p p p p ETB

N = current scan length in 1/10 mm

Set scan mode

SOH F C D M C - r N N N N - - - - ETB

N: 0 = Scanning while printing

N: 1 = Scanning after printing

Enquire scan mode

SOH F C D M C - w p p p p p p p p ETB

Answer

SOH A N - - - - - p p p p p p p p ETB

N = current scan mode

Set scan delay (scanning after printing)

SOH F C D M D - r N N N N - - - - ETB

N = Scan delay in ms [0 ... 9990]

Enquire scan delay

SOH F C D M D - w p p p p p p p p ETB

Answer

SOH A N N N N - - - - p p p p p p p p ETB

N = Current scan delay in ms

Set scan timeout (scanning after printing)

SOH F C D M E - r N N N N - - - - ETB

N = Scan timeout in ms [0 ... 9990]

Enquire scan timeout

SOH F C D M E - w p p p p p p p p ETB

Answer

SOH A N N N N - - - - p p p p p p p p ETB

N = Current scan timeout in ms

Set scanner type

SOH	F	C	D	M	F	-	r	N	N	N	N	-	-	-	-	ETB
-----	---	---	---	---	---	---	---	---	---	---	---	---	---	---	---	-----

N: 5 = Zebra DS457

N: 6 = SICK ICR620

N: 7 = SICK CLV6XX

Enquire scanner type

SOH	F	C	D	M	F	-	w	p	p	p	p	p	p	p	p	p	ETB
-----	---	---	---	---	---	---	---	---	---	---	---	---	---	---	---	---	-----

Answer

SOH	A	N	-	-	-	-	-	p	p	p	p	p	p	p	p	p	ETB
-----	---	---	---	---	---	---	---	---	---	---	---	---	---	---	---	---	-----

N = Current set scanner type

6.1 Scanner Variable

In operating mode 1 (data comparison) the printer has to provide the possibility to define the order of bar code data to scan multiple codes onto a label. Because of this reason it is necessary to define the bar code data in the text statements as scanner 'variable'. The text statement has the following structure:

Scanner variable

SOH	BM	[n]	=	S	V	(a	;	f)	text data	ETB
-----	----	-----	---	---	---	---	---	---	---	---	-----------	-----

'=SV' Identification of scanner variable

a Field active

0 = not active

1 = active, i.e. the code is scanned

f Field number for definition of code order (1 ...)

Examples

Text fix:

(SOH)BM[1]=SV(1;1)123456(ETB)

Text variable (counter):

(SOH)BM[1]=SV(1;1)=CN(10;0;4;+1;1)0001(ETB)

7 Error Messages

Error message	Cause	Remedy
68 Scanner	The connected bar code scanner signals a device error.	Check the connection scanner/printer. Check the scanner (dirty).
69 Scanner NoRead	Bad print quality. Printhead completely soiled or defective. Print speed too high.	Increase the contrast. Clean the printhead or exchange (if necessary). Reduce the print speed.
70 Scanner data	Scanned data does not correspond to the data which is to print.	Exchange printhead.
94 Scanner Timeout	The scanner could not read the bar code within the set timeout time. Defective printhead. Wrinkles in the transfer ribbon. Scanner wrong positioned. Timeout time too short.	Check the printhead. Check the transfer ribbon. Position the scanner correctly, corresponding to the set feeding. Select longer timeout time.

8 Index

C

configuration, settings scanner software..... 11, 12, 13, 14, 15, 16, 17

E

environmentally-friendly disposal 5

error messages 27

F

function menu scanner

 interface parameter..... 22

 scan delay..... 22

 scan length 21

 scan mode 21

 scan offset 20

 scan timeout 22

 scanner mode 19

 scanner setup 20

 type 20

G

general notes..... 5

I

installation, Spectra II 9

P

parameter sets

 scanner 23, 24, 25

 scanner variable 25

product description 6

T

technical data 7, 8



Carl Valentin GmbH
Neckarstraße 78 – 86 u. 94 . 78056 Villingen-Schwenningen
Phone +49 7720 9712-0 . Fax +49 7720 9712-9901
info@carl-valentin.de . www.carl-valentin.de